

EX-92634 Box PC User Manual

Release Date

Revision

July 2007

V0.1

©2005 TopsCCC

All Rights Reserved.

Published in Taiwan

Warning!

This equipment generates, uses and can radiate radio frequency energy and if not installed and used in accordance with the instructions manual, it may cause interference to radio communications.

It has been tested and found to comply with the limits for a Class A computing device pursuant to FCC Rules, which are designed to provide reasonable protection against such interference when operated in a commercial environment. Operation of this equipment in a residential area is likely to cause interference in which case the user at his own expense will be required to take whatever measures may be required to correct the interference.

Electric Shock Hazard – Do not operate the machine with its back cover removed. There are dangerous high voltages inside.

Disclaimer

This information in this document is subject to change without notice. In no event shall TopsCCC Technology Inc. be liable for damages of any kind, whether incidental or consequential, arising from either the use or misuse of information in this document or in any related materials.

Table of Contents

Warning!	2
Disclaimer	2

1.1 Features.....	4
1.2 Specifications.....	4
1.3 Dimensions.....	5
1.4 Mainboard.....	7
1.5 Safety Precautions.....	9
1.6 Brief Description of EX-92634.....	10

2.1 Installation of CPU.....	11
2.2 Installation of HDD.....	12
2.3 Installing the Memory.....	14
2.4 Installing the Jumpers.....	15
2.5 Connectors on the Mainboard.....	19

3.1 BIOS Setup.....	23
---------------------	----

4.1 Installations of Drivers.....	42
-----------------------------------	----

Figure 1.1: Dimensions	6
Figure 1.2: Mainboard Overview	7
Figure 1.3: Rear View.....	10

Chapter 1

1.1 Features

- Intel Celeron M / Pentium M, up to 1.8GHz
- Fanless design
- Intel 82852GM + ICH4
- 1 x 184-pin DDR DIMM with up to 1GB
- 2 x 10/100 Ethernet LAN, 1 x VGA connector
- 3 x COM ports & 4 x USB ports
- Audio Jack (AC'97, Line-in/Line-Out/MIC) by cable
- 1 x 2.5" anti-vibration slim HDD & 1 x CF Socket on board
- 1 x PCI slot support
- Support Single 11~28V/DC Input, support AT/ATX mode

1.2 Specifications

System

CPU:

Socket 479 for Intel Celeron M / Pentium M, up to 1.8GHz

Chipset:

Intel 82852GM + ICH4

System Memory:

DDR DIMM with up to 1GB

DRAM Socket:

One 184-pin DDR DIMM

Drive Bay:

1 x 2.5" anti-vibration slim HDD

BIOS:

Award Flash

Watchdog Timer:

Generates system reset, 256 levels

I/O Port:

3 x COM ports, 4 x USB2.0 ports, 2 x PS/2 keyboard and mouse ports, 1x VGA, Audio Jack (AC'97, Line-in/Line-Out/MIC),

RJ-45 LAN Port:

2 x 10/100Mbps

VGA:

Built-in Intel® 82852GM+ICH4

Certifications:

FCC & CE Class A certified

Mechanical**Construction:**

Heavy steel & Alu. Heatsink

Color:

Blue

Dimensions:

240(W) x 104(D) x 230mm(H)

Power Supply:

11~28V/DC Input, support AT/ATX mode

Environment**Operating temperature:**

0~60 ° C

Storage temperature:

-20 ° C ~ 80 ° C

Relative humidity:

10~90% @ 40 ° C non-condensing

Vibration:

5~17Hz, 0.1" double amplitude displacement

17~640Hz, 1.5G acceleration peak to peak

Shock:

10G acceleration peak to peak (11 millimeters)

1.3 Dimensions

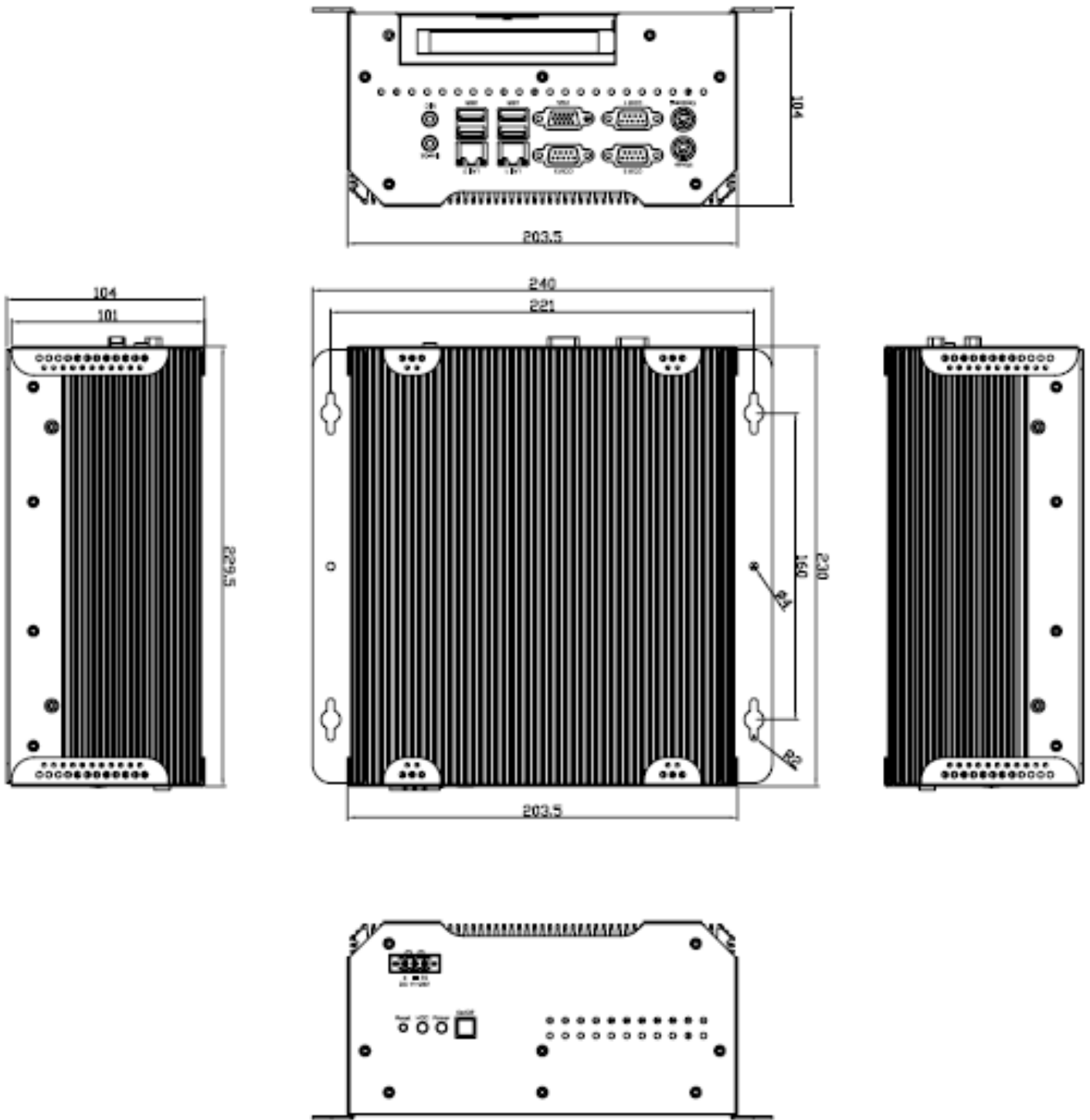

Figure 1.1: Dimensions of the EX-92634

1.4 Mainboard

Introducing the Motherboard

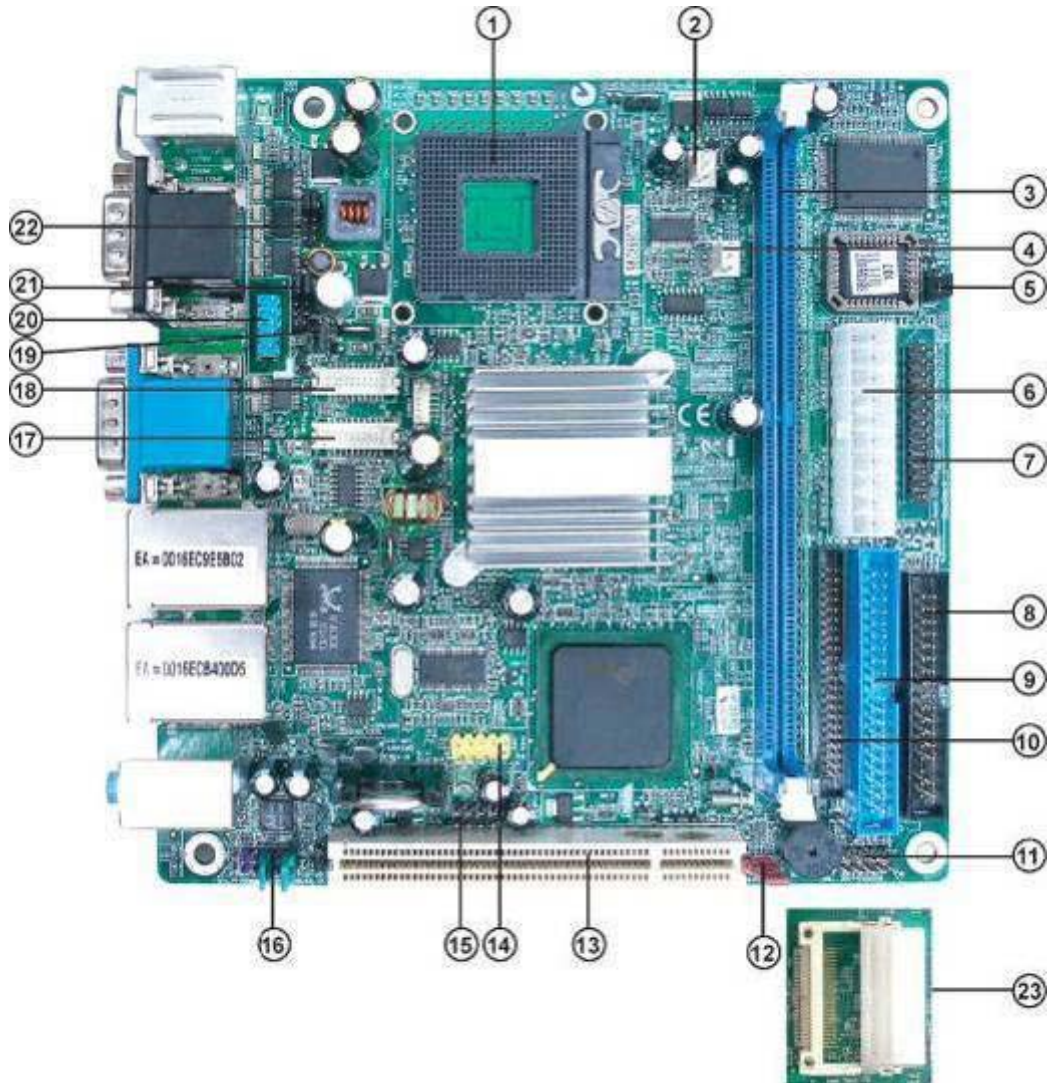

Figure 1.2: Mainboard Overview

Table of Motherboard Components

LABEL		COMPONENT
1	Processor	479 socket for Pentium M/Celeron M CPUs
2	CPU_FAN	CPU cooling fan connector
3	DIMM1	184-pin DDR SDRAM slot
4	SYS_FAN	System cooling fan connector
5	CF_PWR	CF power voltage jumper
6	ATX_PWR	Standard 20-pin ATX power connector
7	LPT	LPT pin header
8	FDD	Floppy disk drive connector
9	IDE2	Secondary IDE connector

10	IDE1	Primary IDE connector
11	PANEL	Front Panel switch/LED header
12	CLR_CMOS	Clear CMOS jumper
13	PCI slot	32-bit PCI add-on card slot
14	USB3	Front Panel USB header
15	DIO	DIO port header
16	AUDIO	Front panel Audio header
17	LVDS2	Low Voltage Differential Signaling Transmitter Channel B
18	LVDS1	Low Voltage Differential Signaling Transmitter Channel A
19	LVDS_PWR	Low Voltage Differential Signaling Power header
20	COM4	Serial port header
21	JP2	COM3/COM4 Ring function selector
22	JP1	COM1/COM2 Ring function selector
23	SCN1	C.F. Socket for installing C.F.(Compact Flash) card

Specifications

System

CPU:

Socket 479 for Intel Celeron M / Pentium M, up to 1.8GHz

CPU FSB Frequency:

400MHz

Chipset:

Intel 855GM + ICH4

DRAM:

1 x 184 pin DDR DIMM max. up to 1GB

BIOS:

Award BIOS with 4 Mbit Flash ROM, ACPI supported

Watchdog:

Generates system reset; 256 levels

Power Supply:

11~28V/DC Input, support AT/ATX mode

Dimensions:

170mm x 170mm (6.69 x 6.69 inches)

Environment

Operating Temperature:

0 ° ~ 60 (32 ° ~ 140)

Storage Temperature:

-20 ° ~ 80 (68 ° ~ 176)

Relative Humidity:

10~90% (non-condensing)

1.5 Safety Precautions

Follow the messages below to avoid your systems from damage:

- * Avoid your system from static electricity on all occasions.
- * Prevent electric shock. Don't touch any components of this card when the card is power-on. Always disconnect power when the system is not in use.
- * Disconnect power when you change any hardware devices. For instance, when you connect a jumper or install any cards, a surge of power may damage the electronic components or the whole system.

1.6 Brief Description of the EX-92634

The EX-92634 is a Fan-less High-efficiency Thermal Solution and ultra-compact standalone Box PC, powered by an Intel Celeron M / Pentium M, up to 1.8GHz, and supporting 4 USB 2.0 ports, 3x COM Ports, 1 x VGA, 1x PCI slots, etc. It is ideal for kiosks, POS systems, airport terminal controllers, digital entertainments, etc. and running factory operations from small visual interface and maintenance applications to large control process applications. The EX-92634 works very well along with any of our Display Monitor series. It absolutely can provide an easy way to perform control and field maintenance. It comes with a DC11~28V wide-ranging power input.



Figure 1.3: Rear View of EX-92634

Chapter 2 _____ Hardware Installation

2.1 Installation of CPU

This section provides information on how to use the jumpers and connectors on the mainboard in order to set up a workable system.

2.1.1 Installing the CPU

The mainboard supports a Socket 479 processor socket for Intel Pentium M or Celeron M processors. The processor socket comes with a screw to secure the processor. As shown in the left picture below, loosen the screw first before inserting the processor. Place the processor into the socket by making sure the notch on the corner of the CPU corresponds with the notch on the inside of the socket. Once the processor slides into the socket, fasten the screw.

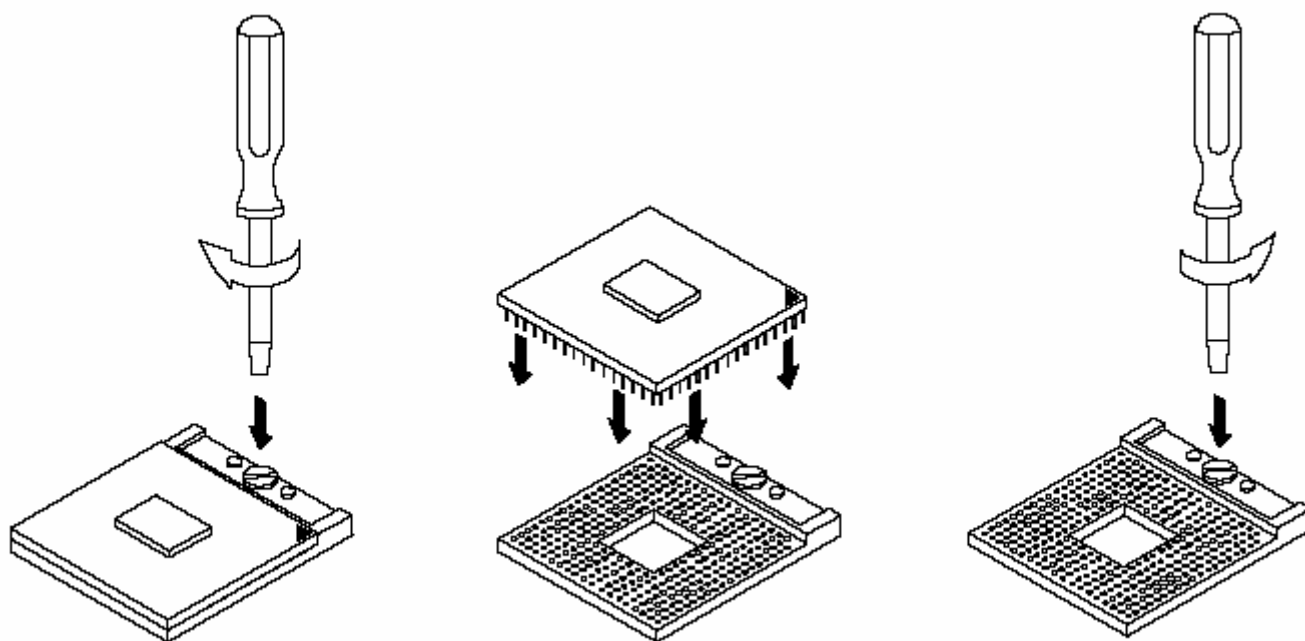

Figure 2.1: Installation of CPU

Note:

Make sure the heat sink and the top surface of the CPU are in total contact to avoid the overheating problem that would cause your system to hang or be unstable.

2.2 Installation of HDD

2.2.1 Removing bottom cover

Use screwdriver to remove the bottom cover 10 screws. Keep the safely for later use. As shown.



2.2.2 Removing HDD Bracket

Disengage the housing of Hard disk drive. Just unscrew the 4 screws, you can easily find the HDD. As shown.

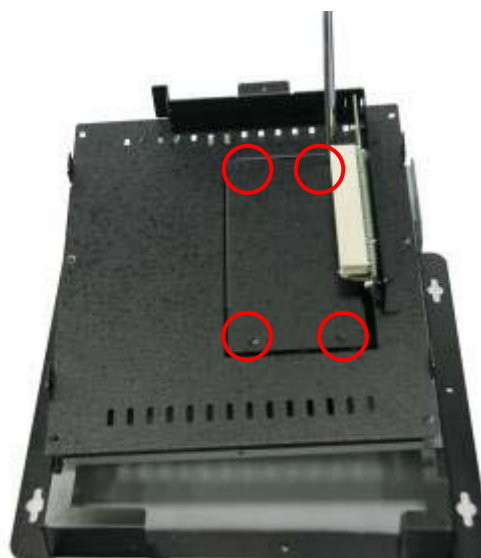

2.2.3 Connecting Cable to HDD

Connect the cable to the HDD, making sure that the red stripe of the cable is on the right side (if connected with the top of the HDD facing upward).



2.2.4 Tightening HDD

Tightly fasten the four screws as circled to secure the HDD.



2.2.5 Installing HDD

Get the 4 screws tightened onto the chassis as shown in the picture.

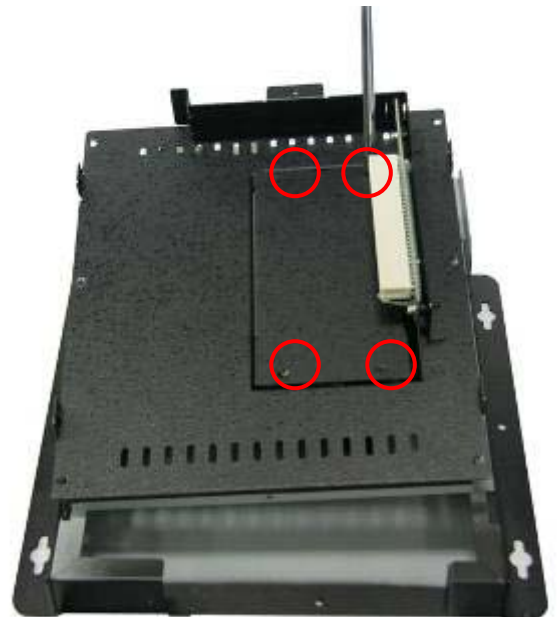

2.3 Installing the Memory

The mainboard supports one DDR memory socket for a maximum total memory of 1GB. The memory module capacities supported are 128MB, 256MB, 512MB and 1GB. The following figure shows the supported DDR DIMM configurations. The Intel 855GME supports configurations defined in the JEDEC DDR DIMM specifications only. Non-JEDEC standard DIMMs such as double-sided x16 DDR SDRAM DIMMs are not supported.

To install the DDR modules, locate the memory slot on the board and perform the following steps:

1. Hold the DDR module so that the key of the DDR module is aligned with those on the memory slot.
2. Gently insert the DDR module into the memory slot and lock the two levers in place.
3. To remove the DDR module, press the two levers with both hands.

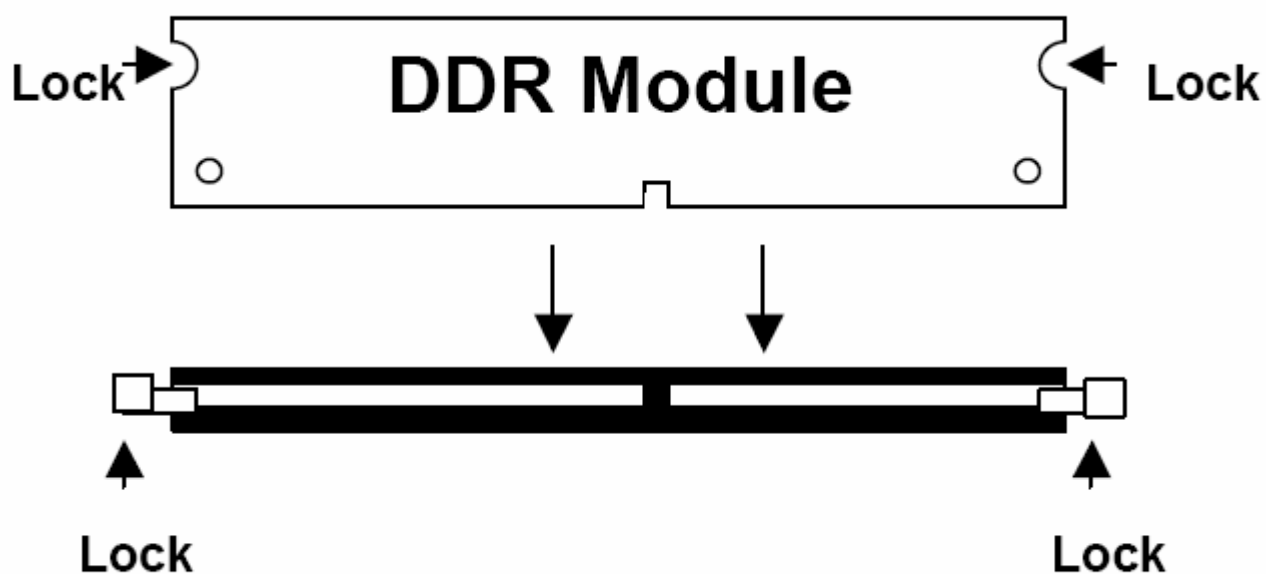
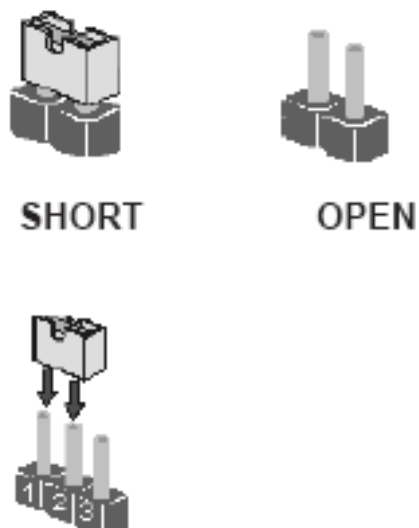

Figure 3.3: Installation of Memory Module

2.4 Installing the Jumpers

Use the motherboard jumpers to set system configuration options. Jumpers with more than one pin are numbered. When setting the jumpers, ensure that the jumper caps are placed on the correct pins.

The illustrations show a 2-pin jumper. When the jumper cap is placed on both pins, the jumper is SHORT. If you remove the jumper cap, or place the jumper cap on just one pin, the jumper is OPEN.





This illustration shows a 3-pin jumper. Pins 1 and 2 are SHORT

Checking Jumper Settings

The following illustration shows the location of the motherboard jumpers. Pin 1 is labeled.



Jumper Settings

Jumper	Type	Description	Setting (default)
CLR_CMOS	3-pin	CLEAR CMOS	1-2: NORMAL 2-3: CLEAR CMOS Before clearing the CMOS, make sure to turn the system off. 
LVDS_PWR	3-pin	LVDS power voltage	1-2: VCC3 2-3: VCC5 
CF_PWR	3-pin	CF power voltage	1-2: VCC3 2-3: VCC5 

Connecting Case Components

After you have installed the motherboard into a case, you can begin connecting the motherboard components. Refer to the following:

- 1 Connect the CPU cooling fan cable to CPU_FAN.
- 2 Connect the system cooling fan connector to SYS_FAN.
- 3 Connect the case switches and indicator LEDs to the PANEL.
- 4 Connect the standard power supply connector to ATX_POWER.

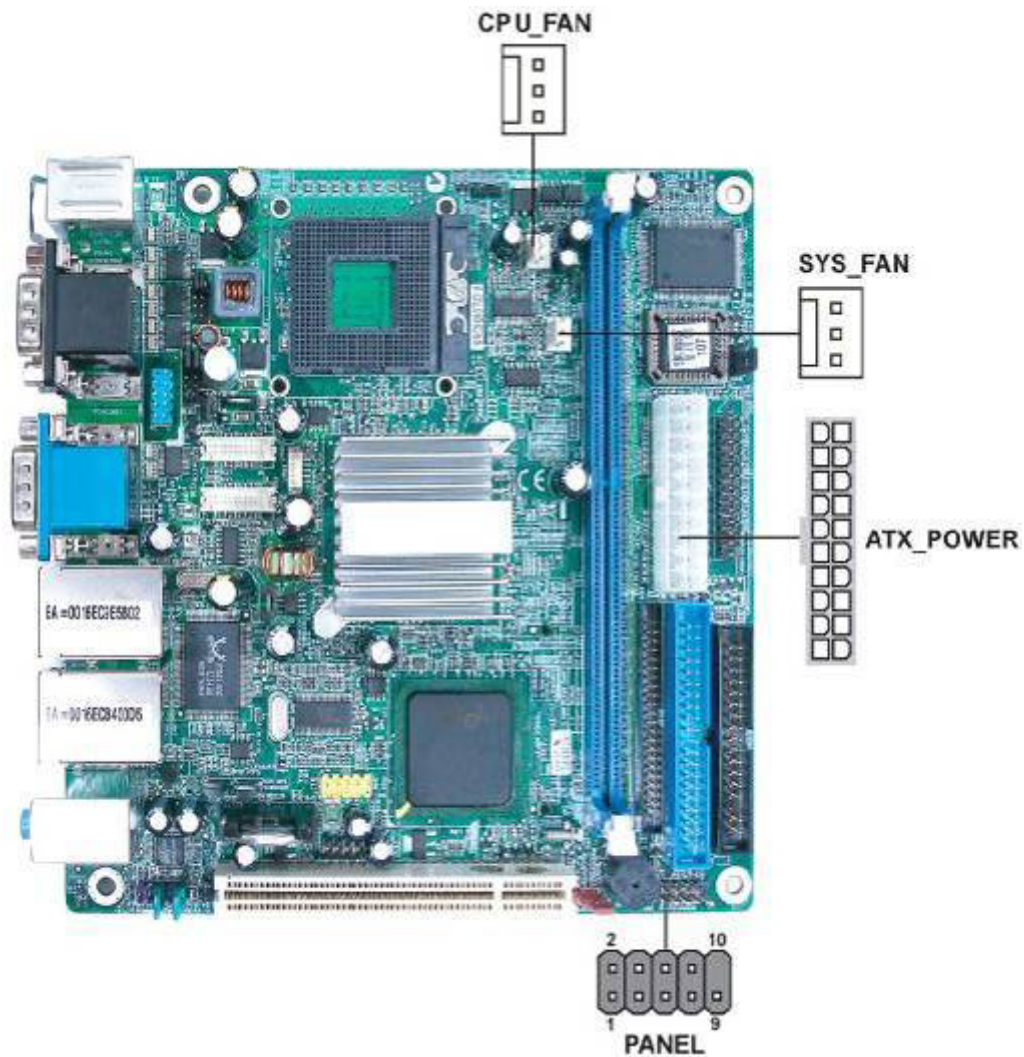

CPU_FAN/SYS_FAN: FAN Power Connectors

Pin	Signal Name	Function
1	GND	System Ground
2	+12V	Power +12V
3	Sense	Sensor

ATX_POWER: ATX 20-pin Power Connector

Pin	Signal Name	Pin	Signal Name
1	VCC3	11	VCC3
2	VCC3	12	-12V
3	GND	13	GND
4	VCC	14	PS-ON#
5	GND	15	GND
6	VCC	16	GND
7	GND	17	GND
8	PWROK	18	-5V
9	5VSB	19	VCC
10	+12V	20	VCC

Front Panel Header

The front panel header (PANEL) provides a standard set of switch and LED headers commonly found on ATX or micro-ATX cases. Refer to the table below for information:

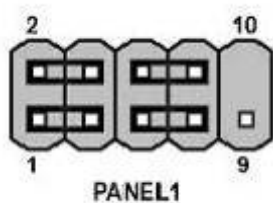

Pin	Signal Name	Function	Pin	Signal Name	Function
1	HD_LED_P	Hard Disk LED+	2	FPPWR/SLP	*MSG LED+
3	HD_LED_N	Hard disk LED-	4	FP PWR/SLP	*MSG LED
5	RST_SW_N	Reset Switch	6	PWR_SW_P	Power Switch
7	RST_SW_P	Reset Switch	8	PWR_SW_N	Power Switch
9	RSVD_DNU	Reserved	10	Key	No pin

*MSG LED (dual color or single color)

Hard Drive Activity LED

Connecting pins 1 and 3 to a front panel mounted LED provides visual indication that data is being read from or written to the hard drive. For the LED to function properly, an IDE drive should be connected to the onboard IDE interface. The LED will also show activity for devices connected to the SCSI (hard drive activity LED) connector.

Installing the Motherboard

Power/Sleep/Message waiting LED

Connecting pins 2 and 4 to a single or dual-color, front panel mounted LED provides power on/off, sleep, and message waiting indication.

Reset Switch

Supporting the reset function requires connecting pin 5 and 7 to a momentary-contact switch that is normally open. When the switch is closed, the board resets and runs POST.

Power Switch

Supporting the power on/off function requires connecting pins 6 and 8 to a momentary-contact switch that is normally open. The switch should maintain contact for at least 50 ms to signal the power supply to switch on or off. The time requirement is due to internal de-bounce circuitry. After receiving a power on/off signal, at least two seconds elapses before the power supply recognizes another on/off signal.

2.5 Connectors on the Mainboard

The connectors on the mainboard allows you to connect external devices, such as keyboard, floppy disk drives, hard disk drives, printers, etc. the following table lists the connectors on the Mainboard and their respective functions

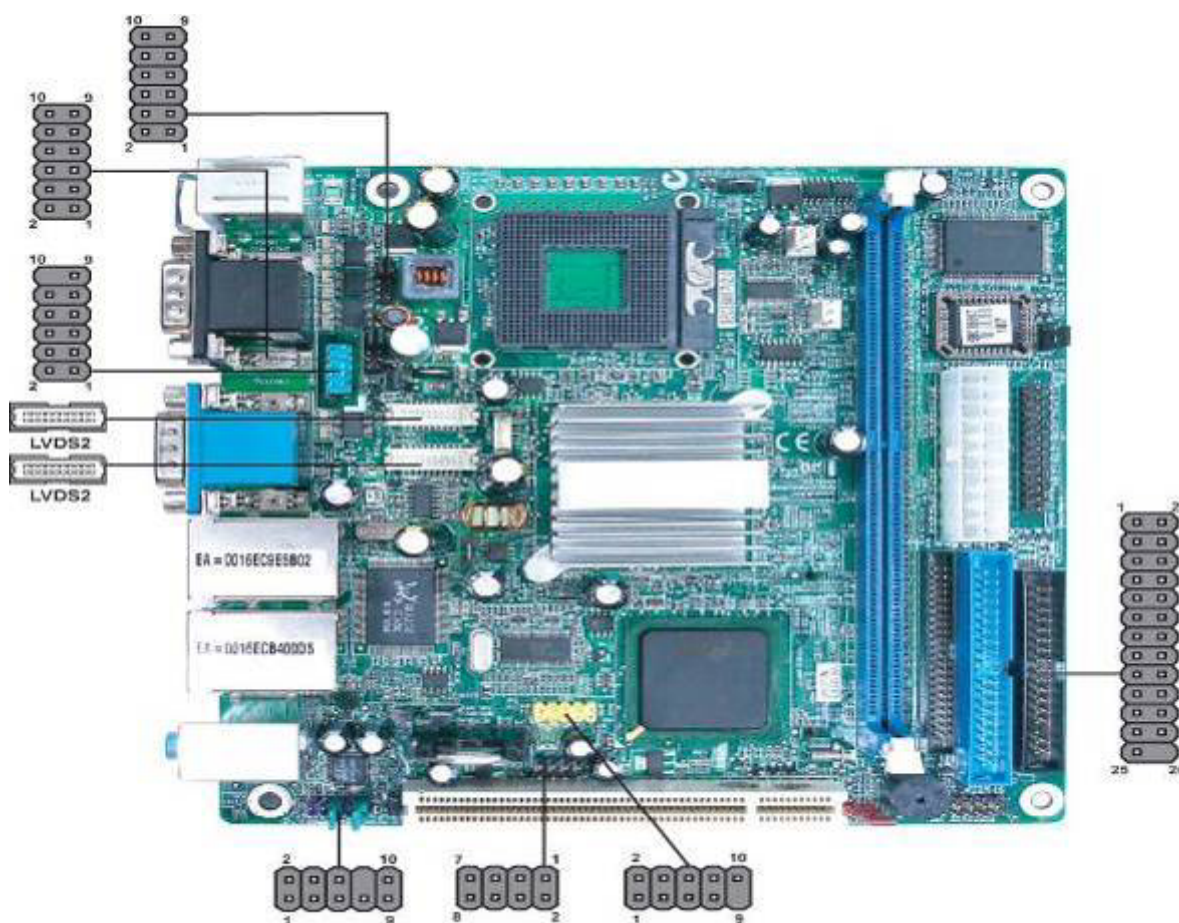

DIO: DIO port header

Pin	Signal Name	Pin	Signal Name
1	GPIO 32	2	GPIO 36
3	GPIO 33	4	GPIO 37
5	GPIO 34	6	GPIO 38
7	GND	8	GND

AUDIO: Front Panel Audio header

This header allows the user to install auxiliary front-oriented microphone and line-out ports for easier access.

Pin	Signal Name	Function
1	AUD_MIC	Front Panel Microphone input signal
2	AUD_GND	Ground used by Analog Audio Circuits
3	MIC_BIAS	Microphone Power

4	AUD_VCC	Filtered +5V used by Analog Audio Circuits
5	AUD_F_R	Right Channel audio signal to Front Panel
6	AUD_RET_R	Right Channel Audio signal to Return from Front Panel
7	REVD	Reserved
8	Key	No Pin
9	AUD_F_L	Left Channel Audio signal to Front Panel
10	AUD_RET_L	Left Channel Audio signal to Return from Front Panel

USB3: Front Panel USB header

The motherboard has four USB ports installed on the rear edge I/O port array. Additionally, some computer cases have USB ports at the front of the case. If you have this kind of case, use auxiliary USB connector to connect the front-mounted ports to the motherboard.

Pin	Signal Name	Function
1	VCC	Power
2	VCC	Power
3	USBP2-N	Negative data signal of
4	USBP3-N	Positive data signal of
5	USBP2-P	Positive data signal of
6	USBP3-P	Negative data signal of
7	GND	System
8	GND	System
9	Key	No pin
10	OC#	Over current detection of

* Please make sure that USB cable has the same pin assignment as indicated above.

A different pin assignment may cause damage or system hang-up.

LVDS1~LVDS2: Low Voltage Differential Signaling Transmitter interface Channel A~B

Pin	Signal Name	Pin	Signal Name
1	VCC	2	VCC
3	VCC	4	VCC
5	Data: YAM0	6	Data: YAM3
7	Data: YAP0	8	Data: YAP3
9	GND	10	GND
11	Data: YAM1	12	Clock: CLKAM
13	Data: YAP1	14	Clock: CLKAP
15	GND	16	GND

17	Data: YAM2	18	GND
19	Data: YAP2	20	GND

JP1~JP2: COM1~4 Ring function selectors

Pin	Signal Name	Pin	Signal Name
1	VCC5	2	VCC5
3	XNRI1	4	XNRI2
5	VCC12	6	VCC12
7	XNRI1	8	XNRI2
9	NRI1	10	NRI2

LPT: LPT header

Pin	Singal Name	Function	Pin	Singal Name	Function
1	STB#	Strobe	2	D0	Data 0
3	D1	Data 1	4	D2	Data 2
5	D3	Data 3	6	D4	Data 4
7	D5	Data 5	8	D6	Data 6
9	D7	Data 7	10	ACK#	Acknowledge
11	BUSY	Busy	12	PE	Paper End
13	SLCT	Select	14	AFD#	Auto Feed
15	ERR#	Error	16	INIT#	Initialize
17	SLIN#	Select In	18	GND	Ground
19	GND	Ground	20	GND	Ground
21	GND	Ground	22	GND	Ground
23	GND	Ground	24	GND	Ground
25	GND	Ground	26	NC	No pin

COM4: Onboard serial port header

Connect a serial port extension bracket to this header to add a second serial port to your system.

Pin	Singal Name	Pin	Singal Name
1	DCDB	2	RxD
3	TxD	4	DTRB
5	Ground	6	DSRB
7	RTSB	8	CTSB
9	RI	10	KEY

Connecting I/O Devices

The backplane of the motherboard has the following I/O ports:

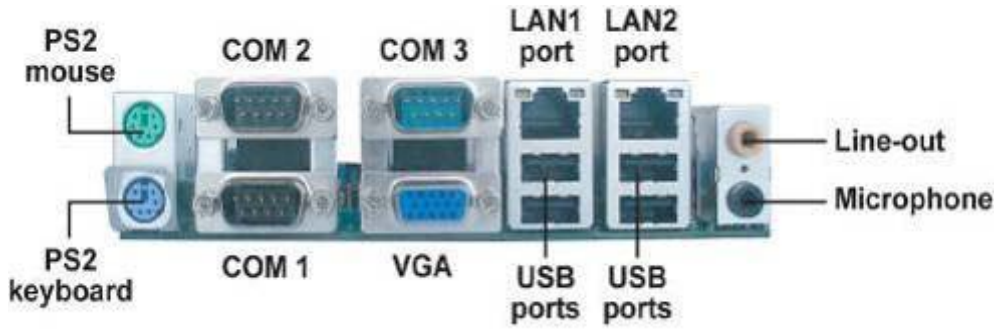

PS2 Mouse Use the upper PS/2 port to connect a PS/2 pointing device.

PS2 Keyboard Use the lower PS/2 port to connect a PS/2 keyboard.

Serial Port (COM1~COM3) Use the COM ports to connect serial devices such as mice or fax/modems.

VGA Port Connect your monitor to the VGA port.

LAN Port (optional) Connect an RJ-45 jack to the LAN port to connect your computer to the Network.

USB Ports Use the USB ports to connect USB devices.

Audio Ports Use the two audio ports to connect audio devices. The first jack (the orange one) is for stereo line-out signal. The second jack is for microphone.

3.1 BIOS Setup

About the Setup Utility

The computer uses the latest Award BIOS with support for Windows Plug and Play. The CMOS chip on the motherboard contains the ROM setup instructions for configuring the motherboard BIOS.

The BIOS (Basic Input and Output System) Setup Utility displays the system's configuration status and provides you with options to set system parameters. The parameters are stored in battery-backed-up CMOS RAM that saves this information when the power is turned off. When the system is turned back on, the system is configured with the values you stored in CMOS.

The BIOS Setup Utility enables you to configure:

- Hard drives, diskette drives and peripherals
- Video display type and display options
- Password protection from unauthorized use
- Power Management features

The settings made in the Setup Utility affect how the computer performs. Before using the Setup Utility, ensure that you understand the Setup Utility options.

This chapter provides explanations for Setup Utility options.

The Standard Configuration

A standard configuration has already been set in the Setup Utility. However, we recommend that you read this chapter in case you need to make any changes in the future.

This Setup Utility should be used:

- when changing the system configuration
- when a configuration error is detected and you are prompted to make changes to the Setup Utility
- when trying to resolve IRQ conflicts
- when making changes to the Power Management configuration
- when changing the password or making other changes to the Security Setup

Entering the Setup Utility

When you power on the system, BIOS enters the Power-On Self Test (POST) routines. POST is a series of built-in diagnostics performed by the BIOS. After the POST routines are completed, the following message appears:

Press DEL to enter SETUP

Pressing the delete key accesses the BIOS Setup Utility:

Phoenix-AwardBIOS CMOS Setup Utility:

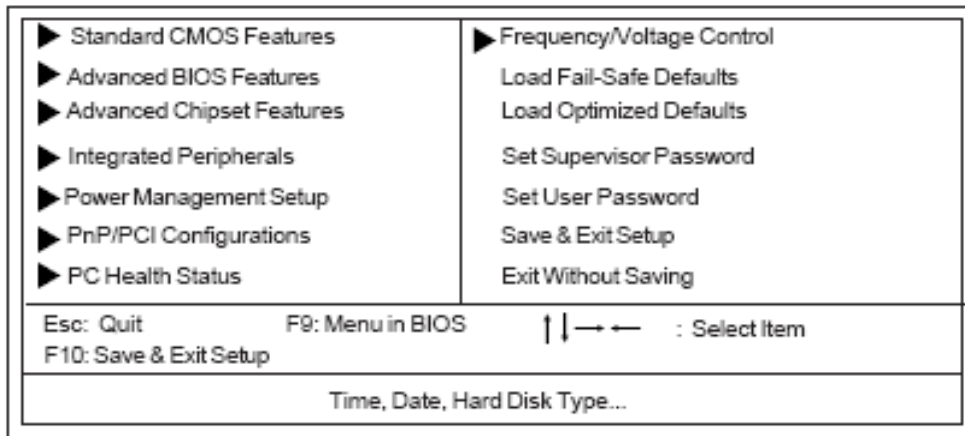

BIOS Navigation Keys

The BIOS navigation keys are listed below:

KEY	FUNCTION
Key	Function
Esc	Exits the current menu
← ↑ ↓ →	Scrolls through the items on a menu
+/-/PU/PD	Modifies the selected field's values
F10	Saves the current configuration and exits setup
F1	Displays a screen that describes all key functions
F5	Loads previously saved values to CMOS
F6	Loads a minimum configuration for troubleshooting
F7	Loads an optimum set of values for peak performance

Updating the BIOS

You can download and install updated BIOS for this motherboard from the manufacturer's Web site. New BIOS provides support for new peripherals, improvements in performance, or fixes for known bugs. Install new BIOS as follows:

- 1 If your motherboard has a BIOS protection jumper, change the setting to allow BIOS flashing.
- 2 If your motherboard has an item called Firmware Write Protect in Advanced BIOS features, disable it. (Firmware Write Protect prevents BIOS from being overwritten.)
- 3 Create a bootable system disk. (Refer to Windows online help for information on creating a bootable system disk.)
- 4 Download the Flash Utility and new BIOS file from the manufacturer's Web site. Copy these files to the system diskette you created in Step 3.

- 5 Turn off your computer and insert the system diskette in your computer's diskette drive. (You might need to run the Setup Utility and change the boot priority items on the Advanced BIOS Features Setup page, to force your computer to boot from the floppy diskette drive first.)
- 6 At the A:\ prompt, type the Flash Utility program name and press <Enter>.
- 7 Type the filename of the new BIOS in the "File Name to Program" text box. Follow the onscreen directions to update the motherboard BIOS.
- 8 When the installation is complete, remove the floppy diskette from the diskette drive and restart your computer. If your motherboard has a Flash BIOS jumper, reset the jumper to protect the newly installed BIOS from being overwritten.

Using BIOS

When you start the Setup Utility, the main menu appears. The main menu of the Setup Utility displays a list of the options that are available. A highlight indicates which option is currently selected. Use the cursor arrow keys to move the highlight to other options. When an option is highlighted, execute the option by pressing <Enter>.

Some options lead to pop-up dialog boxes that prompt you to verify that you wish to execute that option. Other options lead to dialog boxes that prompt you for information.

Some options (marked with a triangle ►) lead to submenus that enable you to change the values for the option. Use the cursor arrow keys to scroll through the items in the submenu.

In this manual, default values are enclosed in parenthesis. Submenu items are denoted by a triangle ►.

Standard CMOS Features

This option displays basic information about your system.

Phoenix-AwardBIOS CMOS Setup Utility
Standard CMOS Features

Date (mm:dd:yy)	Tue, July 11 2001	Item Help
Time (hh:mm:ss)	12 : 8 : 59	
▶ IDE Primary Master	[None]	Menu Level ► Change the day, month, year and century.
▶ IDE Primary Slave	[None]	
▶ IDE Secondary Master	[None]	
▶ IDE Secondary Slave	[None]	
Drive A	[1.44M, 3.5 in.]	
Floppy 3 Mode Support	[Disabled]	
Video	[EGA/VGA]	
Halt On	[All Errors]	
Base Memory	640K	
Extended Memory	31744K	
Total Memory	32768K	

↑ ↓ ← → : Move Enter: Select +/-/PU/PD:Value F10:Save ESC:Exit F1: General Help
F5:Previous Values F6:Fail-Safe Defaults F7:Optimized Defaults

Date and Time

The Date and Time items show the current date and time on the computer. If you are running a Windows OS, these items are automatically updated whenever you make changes to the Windows Date and Time Properties utility.

► IDE Devices (None)

Your computer has two IDE channels (Primary and Secondary) and each channel can be installed with one or two devices (Master and Slave). Use these items to configure each device on the IDE channel.

Press <Enter> to display the IDE submenu:

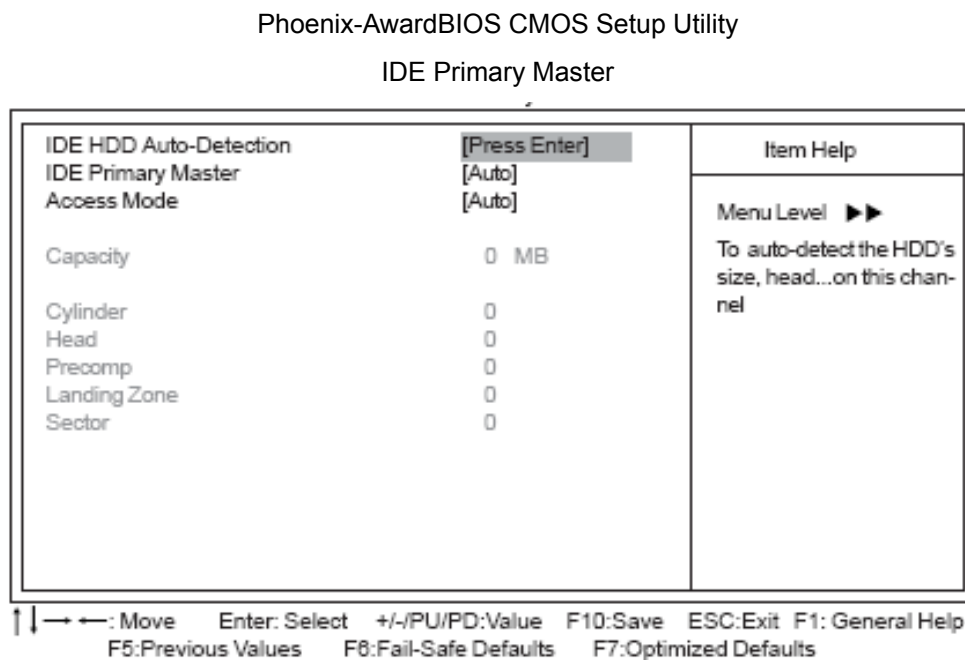

IDE HDD Auto-Detection

Press <Enter> while this item is highlighted to prompt the Setup Utility to automatically detect and configure an IDE device on the IDE channel.

*If you are setting up a new hard disk drive that supports LBA mode, more than one line will appear in the parameter box. Choose the line that lists LBA for an LBA drive.

IDE Primary/Secondary Master/Slave (Auto)

Leave this item at Auto to enable the system to automatically detect and configure IDE devices on the channel. If it fails to find a device, change the value to Manual and then manually configure the drive by entering the characteristics of the drive in the items described below.

Refer to your drive's documentation or look on the drive casing if you need to obtain this information. If no device is installed, change the value to None.

*Before attempting to configure a hard disk drive, ensure that you have the configuration information supplied by the manufacturer of your hard drive. Incorrect settings can result in your system not recognizing the installed hard disk.

Access Mode (Auto)

This item defines ways that can be used to access IDE hard disks such as LBA (Large Block Addressing). Leave this value at Auto and the system will automatically decide the fastest way to access the hard disk drive.

Press <Esc> to return to the Standard CMOS Features page.

Drive A (1.44M, 3.5 in.)

This item defines the characteristics of any diskette drive attached to the system.

Floppy 3 Mode Support (Disabled)

Floppy 3 mode refers to a 3.5-inch diskette with a capacity of 1.2 MB. Floppy 3 mode is sometimes used in Japan.

Video (EGA/VGA)

This item defines the video mode of the system. This motherboard has a built-in VGA graphics system; you must leave this item at the default value.

Halt On (All Errors)

This item defines the operation of the system POST (Power On Self Test) routine. You can use this item to select which types of errors in the POST are sufficient to halt the system.

Base Memory, Extended Memory, and Total Memory

These items are automatically detected by the system at start up time. These are display-only fields. You cannot make changes to these fields.

Advanced BIOS Features

This option defines advanced information about your system.

Phoenix-AwardBIOS CMOS Setup Utility

Advanced BIOS Features

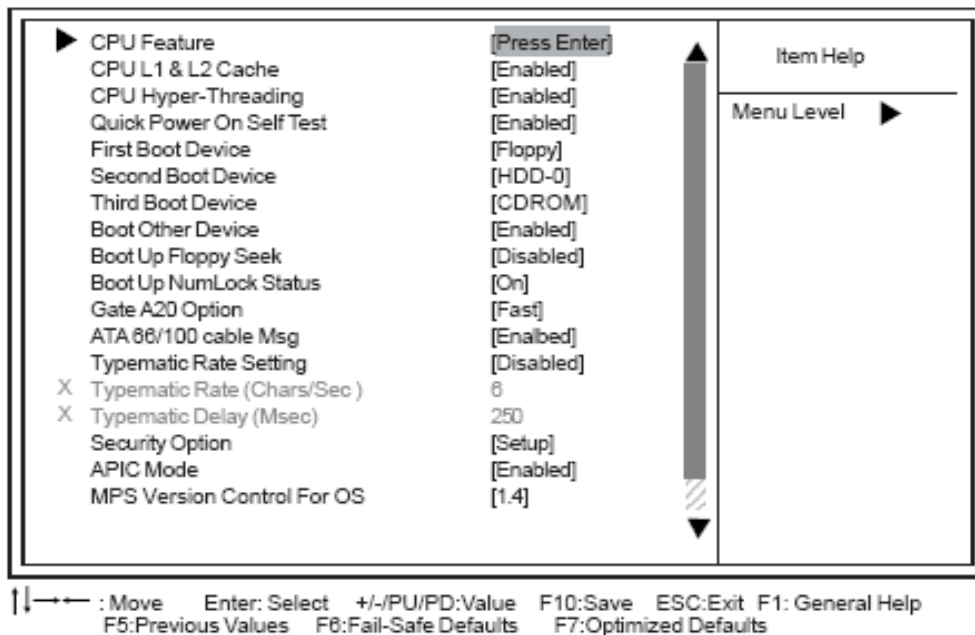

► CPU Feature (Press Enter)

Scroll to this item and press <Enter> to view the following screen, and the following items are available when the motherboard doesn't support Prescott CPU; however, when the motherboard supports Prescott CPU, the items of TM2 Bus Ratio, TM2 VID and Limit CPUID MaxVal will be available.

Phoenix-AwardBIOS CMOS Setup Utility

CPU Feature

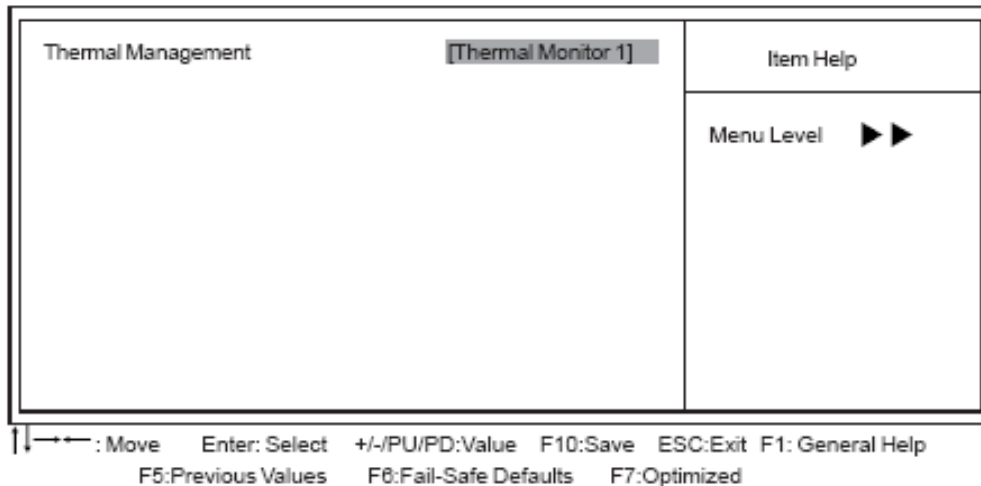

Press <Esc> to return to the Advanced BIOS Features screen.

CPU L1 & L2 Cache (Enabled)

All processors that can be installed in this motherboard use internal level 1 (L1) and external level 2 (L2) cache memory to improve performance. Leave this item at the default value for better performance.

CPU Hyper-Threading (Enabled)

This item is only available when the chipset supports Hyper-Threading and you are using a Hyper-Threading CPU.

Quick Power On Self Test (Enabled)

Enable this item to shorten the power on self testing (POST) and have your system start up faster. You might like to enable this item after you are confident that your system hardware is operating smoothly.

First/Second/Third Boot Device (Floppy/HDD-0/CDROM)

Use these three items to select the priority and order of the devices that your system searches for an operating system at start-up time.

Boot Other Device (Enabled)

When enabled, the system searches all other possible locations for an operating system if it fails to find one in the devices specified under the First, Second, and Third boot devices.

Boot Up Floppy Seek (Disabled)

If this item is enabled, it checks the size of the floppy disk drives at start-up time. You don't need to enable this item unless you have a legacy diskette drive with 360K capacity.

Boot Up NumLock Status (On)

This item defines if the keyboard Num Lock key is active when your system is started.

Gate A20 Option (Fast)

This item defines how the system handles legacy software that was written for an earlier generation of processors. Leave this item at the default value.

ATA 66/100 cable Msg (Enabled)

This item enables or disables the display of the ATA 66/100 Cable MSG.

Typematic Rate Setting (Disabled)

If this item is enabled, you can use the following two items to set the typematic rate and the typematic delay settings for your keyboard.

- **Typematic Rate (Chars/Sec):** Use this item to define how many characters per second are generated by a held-down key.
- **Typematic Delay (Msec):** Use this item to define how many milliseconds must elapse before a held-down key begins generating repeat characters.

Security Option (Setup)

If you have installed password protection, this item defines if the password is required at system start up, or if it is only required when a user tries to enter the Setup Utility.

APIC Mode (Enabled)

This option enables or disables APIC (Advanced Programmable Interrupt Controller) functionality. The APIC is an Intel chip that provides symmetric multi-processing (SMP) for its Pentium systems.

MPS Version Control For OS (1.4)

The BIOS supports versions 1.1 and 1.4 of the Intel multiprocessor specification. Select the version supported by the operation system running on the computer.

OS Select For DRAM > 64 MB (Non-OS2)

This item is only required if you have installed more than 64 MB of memory and you are running the OS/2 operating system. Otherwise, leave this item at the default.

Report No FDD For WIN 95 (No)

Set this item to the default if you are running a system with no floppy drive and using Windows 95; this ensures compatibility with the Windows 95 logo certification.

Small Logo (EPA) Show (Disabled)

Enables or disables the display of the EPA logo during boot.

Advanced Chipset Features

These items define critical timing parameters of the motherboard. You should leave the items on this page at their default values unless you are very familiar with the technical specifications of your system hardware. If you change the values incorrectly, you may introduce fatal errors or recurring instability into your system.

DRAM Timing Selectable	[By SPD]	Item Help
X CAS Latency Time	[2.5]	Menu Level ►
X Active to Precharge Delay	[7]	
X DRAM RAS# to CAS# Delay	[3]	
X DRAM RAS# Precharge	[3]	
DRAM Data Integrity Mode	[Non-ECC]	
Memory Frequency For	[Auto]	
System BIOS Cacheable	[Disabled]	
Video BIOS Cacheable	[Disabled]	
Delayed Transaction	[Enabled]	
Delay Prior to Thermal	[16 Min]	
AGP Aperature Size (MB)	[128]	
On-Chip VGA	[Enabled]	
On-chip Frame Buffer Size	[8M]	
Boot Display	[VBIOS Default]	
Panel Number	[1]	

↑ → ← : Move Enter: Select +/-/PU/PD: Value F10: Save ESC: Exit F1: General Help
F5: Previous Values F8: Fail-Safe Defaults F7: Optimized Defaults

DRAM Timing Selectable (By SPD)

The value in this field depends on performance parameters of the installed memory chips (DRAM). Do not change the value from the factory setting unless you install new memory that has a different performance rating than the original DRAMs.

- CAS Latency Time (2.5): This item controls the timing delay (in clock cycles) before the DRAM starts a read command after receiving it.
- Active to Precharge Delay (7): This precharge time is the number of cycles it takes for DRAM to accumulate its charge before refresh.
- DRAM RAS# to CAS# Delay (3): This field lets you insert a timing delay between the CAS and RAS strobe signals, used when DRAM is written to, read from, or refreshed. Disabled gives faster performance; and Enabled gives more stable performance.
- DRAM RAS# Precharge (3): Select the number of CPU clocks allocated for the Row Address Strobe (RAS#) signal to accumulate its charge before the DRAM is refreshed. If insufficient time is allowed, refresh may be incomplete and data lost.

DRAM Data Integrity Mode (Non-ECC)

This item is used to configure your RAM's data integrity mode.

Memory Frequency For (Auto)

This item sets the main memory frequency. When you used an external graphics card, you can adjust this to enable the best performance for your system.

System BIOS Cacheable (Disabled)

This item allows the system to be cached in memory for faster execution. Enable this item for better performance.

Video BIOS Cacheable (Disabled)

When this is enabled, the Video RAM will be cached resulting to better performance. However, if any

program was written to this memory area, this may result to system error.

Delayed Transaction (Enabled)

The chipset has an embedded 32-bit posted write buffer to support delayed transaction cycles. Enable this item to support compliance with PCI specification version 2.1.

Delay Prior to Thermal (16 Min)

Enables you to set the delay time before the CPU enters auto thermal mode.

AGP Aperture Size (MB) (128)

This item defines the size of the aperture if you use an AGP graphics adapter. The AGP aperture refers to a section of the PCI memory address range used for graphics memory. We recommend that you leave this item at the default value.

On-Chip VGA (Enabled)

Enables and disables the built-in on-chip VGA.

On-Chip Frame Buffer Size (8M)

This item allows you to set the VGA frame buffer size.

Boot Display (VBIOS Default)

This item is for Intel define ADD card only.

Panel Number (1)

This item is used to select the number to support LVDS panel.

Integrated Peripherals

These options display items that define the operation of peripheral components on the system's input/output ports.

Phoenix-AwardBIOS CMOS Setup Utility

Integrated Peripherals

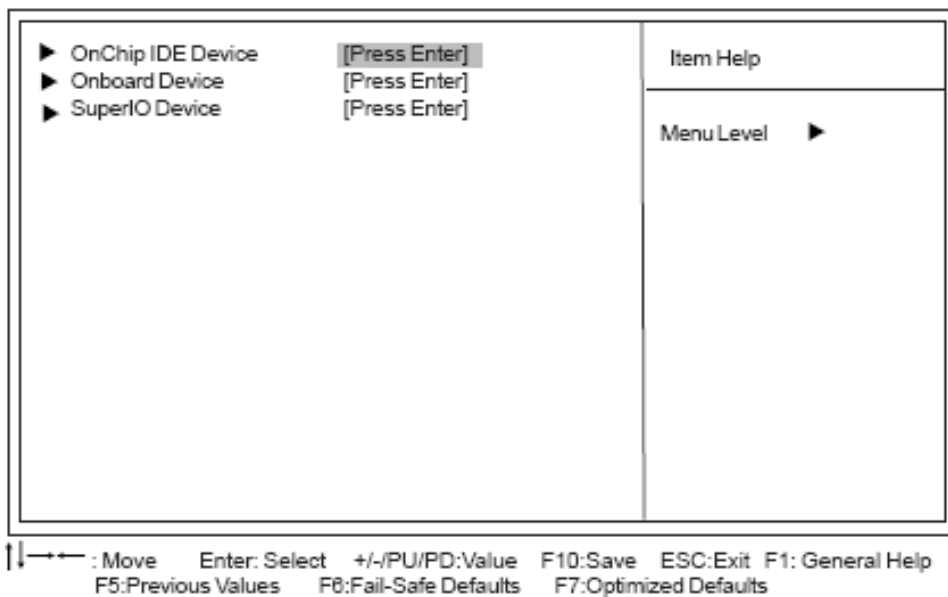

► OnChip IDE Device (Press Enter)

Phoenix-AwardBIOS CMOS Setup Utility

OnChip IDE Device

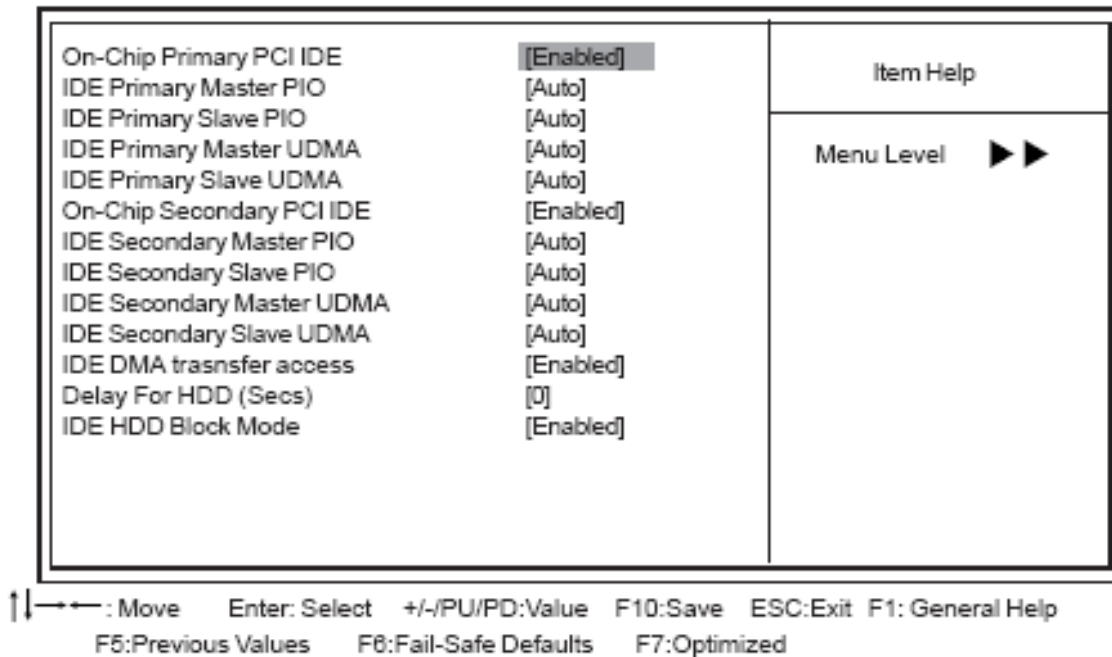

On-Chip Primary/Secondary PCI IDE (Enabled)

Use these items to enable or disable the PCI IDE channels that are integrated on the motherboard.

IDE Primary/Secondary Master/Slave PIO (Auto)

Each IDE channel supports a master device and a slave device. These four items let you assign the kind of PIO (Programmed Input/Output) was used by the IDE devices. Choose Auto to let the system auto detect which PIO mode is best, or select a PIO mode from 0-4.

IDE Primary/Secondary Master/Slave UDMA (Auto)

Each IDE channel supports a master device and a slave device. This motherboard supports UltraDMA technology, which provides faster access to IDE devices. If you install a device that supports UltraDMA, change the appropriate item on this list to Auto. You may have to install the UltraDMA driver supplied with this motherboard in order to use an UltraDMA device.

IDE DMA transfer access (Enabled)

This item allows you to enable the transfer access of the IDE DMA.

Delay For HDD (Secs) (0)

Users may set a delay from 1 to 15 seconds in the cold boot process. Some hard disk drives need extra time to spin up in order to identify correctly. If the system does not start after the memory test, try to add times in this field.

IDE HDD Block Mode (Enabled)

Enable this field if your IDE hard drive supports block mode. Block mode enables BIOS to automatically detect the optimal number of block read and writes per sector that the drive can support and improves the speed of access to IDE devices.

Press <Esc> to return to the Integrated Peripherals page.

► Onboard Device (Press Enter)

Phoenix-AwardBIOS CMOS Setup Utility Onboard Device

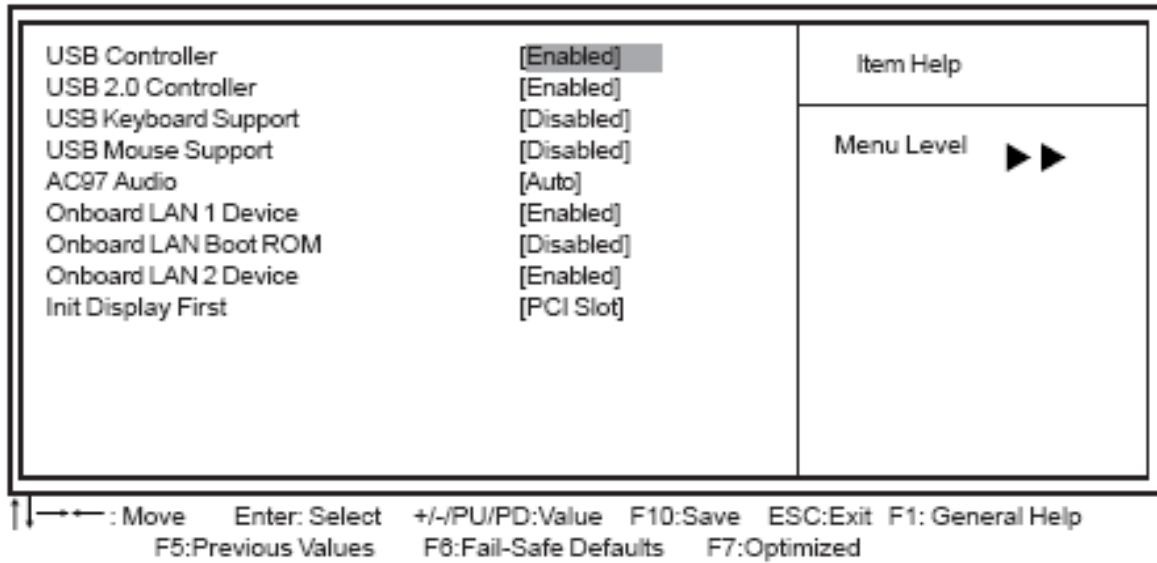

USB Controller (Enabled)

Enable this item if you plan to use the Universal Serial Bus ports on this motherboard.

USB 2.0 Controller (Enabled)

Enable this item if you want to use the USB 2.0.

USB Keyboard Support (Disabled)

Enable this item if you plan to use a keyboard connected through the USB port in a legacy operating system (such as DOS) that does not support Plug and Play.

USB Mouse Support (Disabled)

Enable this item if you plan to use a mouse connected through the USB port in a legacy operating system (such as DOS) that does not support Plug and Play.

AC97 AUDIO (Auto)

Enables or disables the onboard audio chip. Disable this item if you are going to install a PCI audio add-on card.

Onboard LAN 1 Device (Enabled)

This option allows you to enable or disable the onboard LAN function.

Onboard LAN Boot ROM (Disabled)

Use this item to enable and disable the booting from the onboard LAN or a network add-in card with a remote boot ROM installed.

Onboard LAN 2 Device (Enabled)

This option allows you to enable or disable the onboard LAN function.

Init Display First (PCI Slot)

Use this item to specify whether your graphics adapter is installed in one of the PCI slots or is integrated on the motherboard.

Press <Esc> to return to the Integrated Peripherals page.

► SuperIO Device (Press Enter)

Phoenix-AwardBIOS CMOS Setup Utility

SuperIO Device

POWER ON Function	[BUTTON ONLY]	Item Help
Hot Key Power ON	[Ctrl-F1]	
Onboard FDC Controller	[Enabled]	
Onboard Serial Port 1	[3F8/IRQ4]	Menu Level ►►
Onboard Serial Port 2	[2F8/IRQ3]	
Onboard Serial Port 3	[3E8]	
Serial Port 3 Use IRQ	[IRQ10]	
Onboard Serial Port 4	[2E8]	
Serial Port 4 Use IRQ	[IRQ11]	
Onboard Parallel Port	[378/IRQ7]	
Parallel Port Mode	[ECP]	
EPP Mode Select	[EPP1.7]	
ECP Mode Use DMA	[3]	
Power On After Power Fail	[Off]	

↑↓←→: Move Enter: Select +/-/PU/PD:Value F10:Save ESC:Exit F1: General Help
F5:Previous Values F8:Fail-Safe Defaults F7:Optimized

POWER ON Function (BUTTON ONLY)

This feature allows you to set the method by which your system can be turned on.

Hot Key Power On (Ctrl-F1)

When the POWER ON Function is set to Hot Key, use this item to set the hot key combination that turns on the system.

Onboard FDC Controller (Enabled)

This option enables the onboard floppy disk drive controller.

Onboard Serial Port1~3 (3F8/IRQ4, 2F8/IRQ3)

These options are used to assign the I/O address and interrupt request (IRQ) for onboard serial port1~2.

Onboard Serial Port3 (3E8)

These options are used to assign the I/O address and interrupt request (IRQ) for onboard serial port3.

Serial Port 3 Use IRQ (IRQ10)

This item is used to select an IRQ for the onboard serial port 3.

Onboard Serial Port4(2E8)

This option is used to assign the I/O address and interrupt request (IRQ) for onboard serial port4.

Serial Port 4 Use IRQ (IRQ11)

This item is used to select an IRQ for the onboard serial port 4.

Onboard Parallel Port (378/IRQ7)

This option is used to assign the I/O address and interrupt request (IRQ) for the onboard parallel port.

Parallel Port Mode (ECP)

Enables you to set the data transfer protocol for your parallel port. There are four options: SPP (Standard Parallel Port), EPP (Enhanced Parallel Port), ECP (Extended Capabilities Port), and ECP+EPP.

SPP allows data output only. Extended Capabilities Port (ECP) and Enhanced Parallel Port (EPP) are bi-directional modes, allowing both data input and output. ECP and EPP modes are only supported with EPP- and ECP-aware peripherals.

EPP Mode Select (EPP1.7)

The onboard parallel port is EPP spec. compliant, after you choose the onboard parallel port with EPP function. Set the EPP version to 1.7 spec or 1.9 spec.

ECP Mode Use DMA (3)

When the onboard parallel port is set to ECP mode, the parallel port can use DMA3 or DMA1.

Power On After Power Fail (Off)

This item enables your computer to automatically restart or return to its last operating status after power returns from a power failure.

Press <Esc> to return to the Integrated Peripherals page.

Power Management Setup

This option lets you control system power management. The system has various power-saving modes including powering down the hard disk, turning off the video, suspending to RAM, and software power down that allows the system to be automatically resumed by certain events.

The power-saving modes can be controlled by timeouts. If the system is inactive for a time, the timeouts begin counting. If the inactivity continues so that the timeout period elapses, the system enters a power-saving mode. If any item in the list of Reload Global Timer Events is Enabled, then any activity on that item will reset the timeout counters to zero.

If the system is suspended or has been powered down by software, it can be resumed by a wake up call that is generated by incoming traffic to a modem, a LAN card, a PCI card, or a fixed alarm on the system realtime clock

Phoenix-AwardBIOS CMOS Setup Utility

Power Management Setup

ACPI Suspend Type	[S3 (STR)]	Item Help
x Run VGABIOS if S3 Resume	[Auto]	Menu Level ▶
Video Off Method	[DPMS]	
Video Off In Suspend	[Yes]	
Suspend Type	[Stop Grant]	
Modem Use IRQ	[3]	
Suspend Mode	[Disabled]	
HDD Power Down	[Disabled]	
Soft-Off by PWR-BTTN	[Instant-Off]	
Wake-Up by PCI card	[Enabled]	
Power On by Ring	[Disabled]	
Wake Up On LAN	[Disabled]	
Resume by Alarm	[Disabled]	
x Date (of Month) Alarm	0	
x Time (hh:mm:ss) Alarm	0 0 0	
** Reload Global Timer Events **		
Primary IDE 0	[Disabled]	
Primary IDE 1	[Disabled]	

↑ ← → : Move Enter: Select +/-/PU/PD: Value F10: Save ESC: Exit F1: General Help
F5: Previous Values F8: Fail-Safe Defaults F7: Optimized Defaults

ACPI Suspend Type (S3(STR))

Use this item to define how your system suspends. In the default, S1 (POS), the suspend mode is equivalent to a software power down. If you select S3 (STR), the suspend mode is suspend to RAM, i.e., the system shuts down with the exception of a refresh current to the system memory.

- Run VGABIOS if S3 Resume (Auto): Use this item to initialize the VGA BIOS from S3 (Suspend to RAM) sleep state.

Video Off Method (DPMS)

This item defines how the video is powered down to save power. This item is set to DPMS (Display Power Management Software) by default.

Video Off In Suspend (Yes)

This option defines if the video is powered down when the system is put into suspend mode.

Suspend Type (Stop Grant)

If this item is set to the default Stop Grant, the CPU will go into Idle Mode during power saving mode.

MODEM Use IRQ (3)

If you want an incoming call on a modem to automatically resume the system from a power-saving mode, use this item to specify the interrupt request line (IRQ) that is used by the modem. You might have to connect the fax/modem to the motherboard Wake On Modem connector for this feature to work.

Suspend Mode (Disabled)

The CPU clock will be stopped and the video signal will be suspended if no Power Management events occur for a specified length of time. Full power function will return when a Power Management

event is detected. Options are from 1 Min to 1 Hour and Disabled.

HDD Power Down (Disabled)

The IDE hard drive will spin down if it is not accessed within a specified length of time. Options are from 1 Min to 15 Min and Disable.

Soft-Off by PWR-BTTN (Instant-Off)

Under ACPI (Advanced Configuration and Power management Interface) you can create a software power down. In a software power down, the system can be resumed by Wake Up Alarms. This item lets you install a software power down that is controlled by the power button on your system. If the item is set to Instant-Off, then the power button causes a software power down. If the item is set to Delay 4 Sec. then you have to hold the power button down for four seconds to cause a software power down.

Wake-Up by PCI Card (Enabled)

When this item is enabled, the system power will be turned on if there is any PCI card activity.

Power On by Ring (Disabled)

If this item is enabled, it allows the system to resume from a software power down or a power-saving mode whenever there is an incoming call to an installed fax/modem. You have to connect the fax/modem to the motherboard

Wake Up On LAN (Disabled)

When set to Enabled, the system power will be turned on if the LAN port receives an incoming signal. You have to connect fax/modem to the motherboard Wake On LAN connector for this feature to work.

Resume by Alarm (Disabled)

When set to Enabled, additional fields become available and you can set the date (day of the month), hour, minute and second to turn on your system. When set to 0 (zero) for the day of the month, the alarm will power on your system every day at the specified time.

- Date (of Month) Alarm (0): Date (on Month) Alarm lets you select a day from 1 to 31.
- Time (hh:mm:ss) Alarm (0:0:0): Time Alarm lets you select a time for the alarm in hours, minutes, and seconds.

**** Reload Global Timer Events ****

Global Timer (power management) events are I/O events whose occurrence can prevent the system from entering a power saving mode or can awaken the system from such a mode. In effect, the system remains alert for anything that occurs to a device that is configured as Enabled, even when the system is in a power-down mode.

Primary/Secondary IDE 1/0 (Disabled)

When these items are enabled, the system will restart the power-saving timeout counters when any activity is detected on any of the drives or devices on the primary or secondary IDE channels.

FDD, COM, LPT Port (Disabled)

When this item is enabled, the system will restart the power-saving timeout counters when any activity is detected on the floppy disk drive, serial ports, or the parallel port.

PCI PIRQ[A-D]# (Disabled)

When this item is enabled, any activity from one of the listed devices wakes up the system.

PNP/PCI Configurations

This section describes configuring the PCI bus system. PCI (Peripheral Component Interconnect) is a system, which allows I/O devices to operate at speeds nearing CPU's when they communicate with own special components. All the options describes in this section are important and technical and it is strongly recommended that only experienced users should make any changes to the default settings.

Phoenix-AwardBIOS CMOS Setup Utility

PnP/PCI Configurations

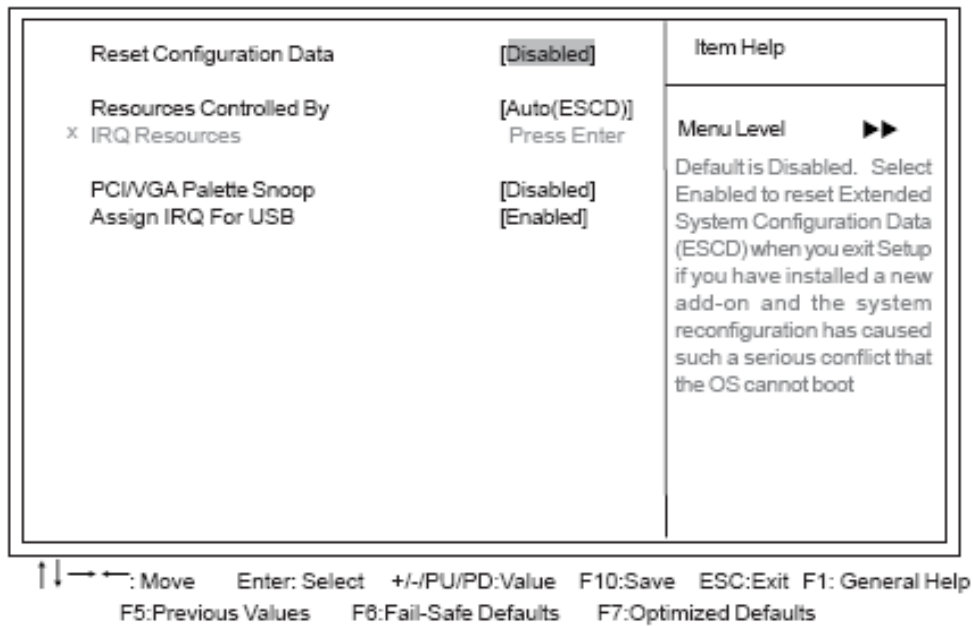

Reset Configuration Data (Disabled)

When you enable this item and restart the system, any Plug and Play configuration data stored in the BIOS Setup is cleared from memory.

Resources Controlled By (Auto(ESCD))

You should leave this item at the default Auto(ESCD). Under this setting, the system dynamically allocates resources to Plug and Play devices as they are required. If you cannot get a legacy ISA (Industry Standard Architecture) expansion card to work properly, you might be able to solve the problem by changing this item to Manual, and then opening up the IRQ Resources submenu.

- **IRQ Resources:** In the IRQ Resources submenu, if you assign an IRQ to Legacy ISA, then that Interrupt Request Line is reserved for a legacy ISA expansion card. Press <Esc> to close the IRQ Resources submenu. In the Memory Resources submenu, use the first item Reserved Memory Base to set the start address of the memory you want to reserve for the ISA expansion card. Use the section item Reserved Memory Length to set the amount of reserved memory. Press <Esc> to close the Memory Resources submenu.

PCI/VGA Palette Snoop (Disabled)

This item is designed to overcome problems that can be caused by some non-standard VGA cards. This board includes a built-in VGA system that does not require palette snooping so you must leave

this item disabled.

Assign IRQ For USB (Enabled)

“Enable” or “Disable” this item when users are to assign IRQ for the USB interface onboard.

PC Health Status

On motherboards that support hardware monitoring, this item lets you monitor the parameters for critical voltages, critical temperatures, and fan speeds.

Phoenix-AwardBIOS CMOS Setup Utility

PC Health Status

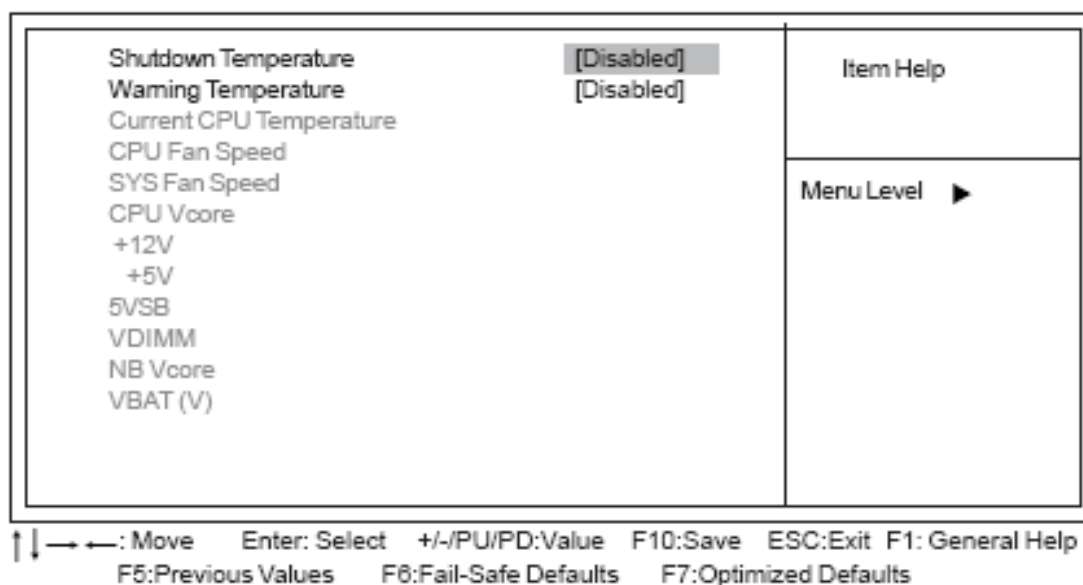

Shutdown Temperature (Disabled)

Enables you to set the maximum temperature the system can reach before powering down.

Warning Temperature (Disabled)

Use this item to set the warning temperature level for the processor.

System Component Characteristics

These items allow end users and technicians to monitor data provided by the BIOS on this motherboard. You cannot make changes to these fields.

- Current CPU Temperature
- CPU Fan Speed
- SYS Fan Speed
- CPU Vcore
- +12V
- +5V
- 5VSB
- VDIMM
- NB Vcore
- VBAT (V)

Frequency/Voltage Control

This item enables you to set the clock speed and system bus for your system. The clock speed and system bus are determined by the kind of processor you have installed in your system.

Phoenix-AwardBIOS CMOS Setup Utility

Frequency/Voltage Control

Auto Detect PCI Clk	[Enabled]	Item Help
Spread Spectrum	[Enabled]	
CPU Clock	[100MHz]	Menu Level ▶

← → : Move Enter: Select +/-/PU/PD:Value F10:Save ESC:Exit F1: General Help
F5:Previous Values F8:Fail-Safe Defaults F7:Optimized Defaults

Auto Detect PCI Clk (Enabled)

When this item is enabled, BIOS will disable the clock signal of free PCI slots.

Spread Spectrum (Enabled)

If you enable spread spectrum, it can significantly reduce the EMI (Electro-Magnetic Interference) generated by the system.

CPU Clock (100MHz)

Use the CPU Host Clock to set the frontside bus frequency for the installed processor (usually 200 MHz, 133 MHz, or 100 MHz).

Load Fail-Safe Defaults Option

This option opens a dialog box that lets you install fail-safe defaults for all appropriate items in the Setup Utility: Press <Y> and then <Enter> to install the defaults. Press <N> and then <Enter> to not install the defaults. The fail-safe defaults place no great demands on the system and are generally stable. If your system is not functioning correctly, try installing the fail-safe defaults as a first step in getting your system working properly again. If you only want to install fail-safe defaults for a specific option, select and display that option, and then press <F6>.

Load Optimized Defaults Option

This option opens a dialog box that lets you install optimized defaults for all appropriate items in the Setup Utility. Press <Y> and then <Enter> to install the defaults. Press <N> and then <Enter> to not install the defaults. The optimized defaults place demands on the system that may be greater than the performance level of the components, such as the CPU and the memory. You can cause fatal errors or instability if you install the optimized defaults when your hardware does not support them. If you only

want to install setup defaults for a specific option, select and display that option, and then press <F7>.

*Users please remain the factory BIOS default setting of “Load optimized Defaults” when install Operation System onto your system.

Set Supervisor/User Password

When this function is selected, the following message appears at the center of the screen to assist you in creating a password.

ENTER PASSWORD

Type the password, up to eight characters, and press <Enter>. The password typed now will clear any previously entered password from CMOS memory. You will be asked to confirm the password. Type the password again and press <Enter>. You may also press <Esc> to abort the selection.

To disable password, just press <Enter> when you are prompted to enter password. A message will confirm the password being disabled. Once the password is disabled, the system will boot and you can enter BIOS Setup freely.

PASSWORD DISABLED

If you have selected “System” in “Security Option” of “BIOS Features Setup” menu, you will be prompted for the password every time the system reboots or any time you try to enter BIOS Setup.

If you have selected “Setup” at “Security Option” from “BIOS Features Setup” menu, you will be prompted for the password only when you enter BIOS Setup.

Supervisor Password has higher priority than User Password. You can use Supervisor Password when booting the system or entering BIOS Setup to modify all settings. Also you can use User Password when booting the system or entering BIOS Setup but can not modify any setting if Supervisor Password is enabled.

Save & Exit Setup Option

Highlight this item and press <Enter> to save the changes that you have made in the Setup Utility and exit the Setup Utility. When the Save and Exit dialog box appears, press <Y> to save and exit, or press <N> to return to the main menu:

Exit Without Saving

Highlight this item and press <Enter> to discard any changes that you have made in the Setup Utility and exit the Setup Utility. When the Exit Without Saving dialog box appears, press <Y> to discard changes and exit, or press <N> to return to the main menu.

*If you have made settings that you do not want to save, use the “Exit Without Saving” item and press <Y> to discard any changes you have made.

Chapter 4 Installation of Drivers

This chapter describes the installation procedures for software and drivers under the Windows 98SE, Windows ME, Windows 2000 and Windows XP. The software and drivers are included with the motherboard. The contents include **Intel Chipset Software Installation Utility, VGA Drivers Installation, AC97 Codec Audio Driver Installation, and Intel PRO LAN Drivers Installation.**

Important Note:

After installing your Windows operating system (Windows 98SE/ME/2000/XP), you must install first the Intel Chipset Software Installation Utility before proceeding with the installation of drivers.

4.2 Installations of Drivers

Intel Chipset Software Installation

The Intel Chipset Drivers should be installed first before the software drivers to enable Plug&Play INF support for Intel chipset components. Follow the instructions below to complete the installation Under Windows 98SE/ME/2000/XP

1. Insert the TopsCCC product CD that comes with the board.
2. Click “ **Intel® Chipset software installation Utility** “



3. When the Welcome screen appears, please click “ Next “ to Continue.

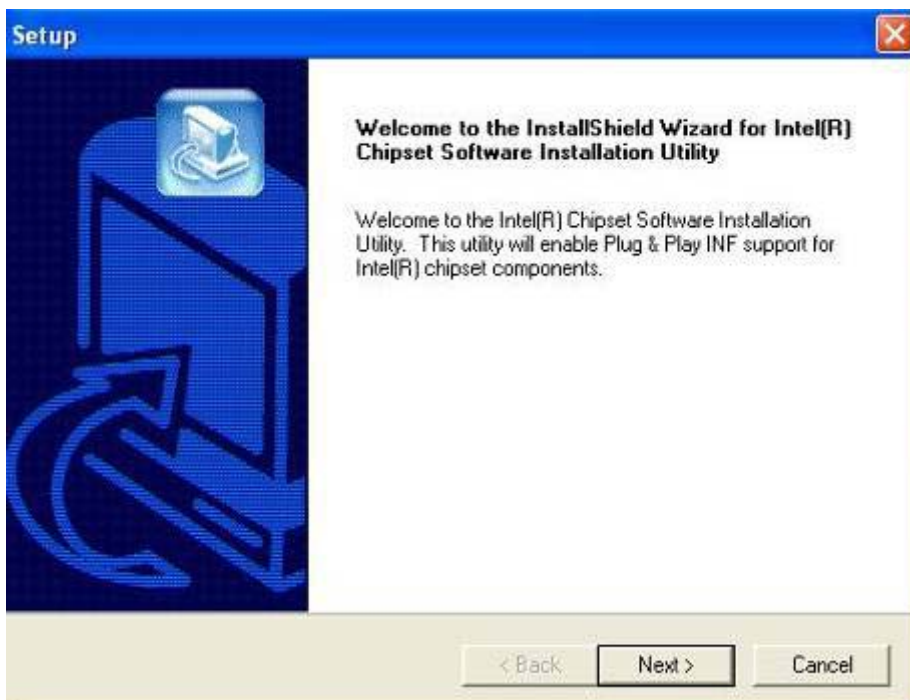

4. Click *Yes* to accept the software license agreement and proceed with the installation process.

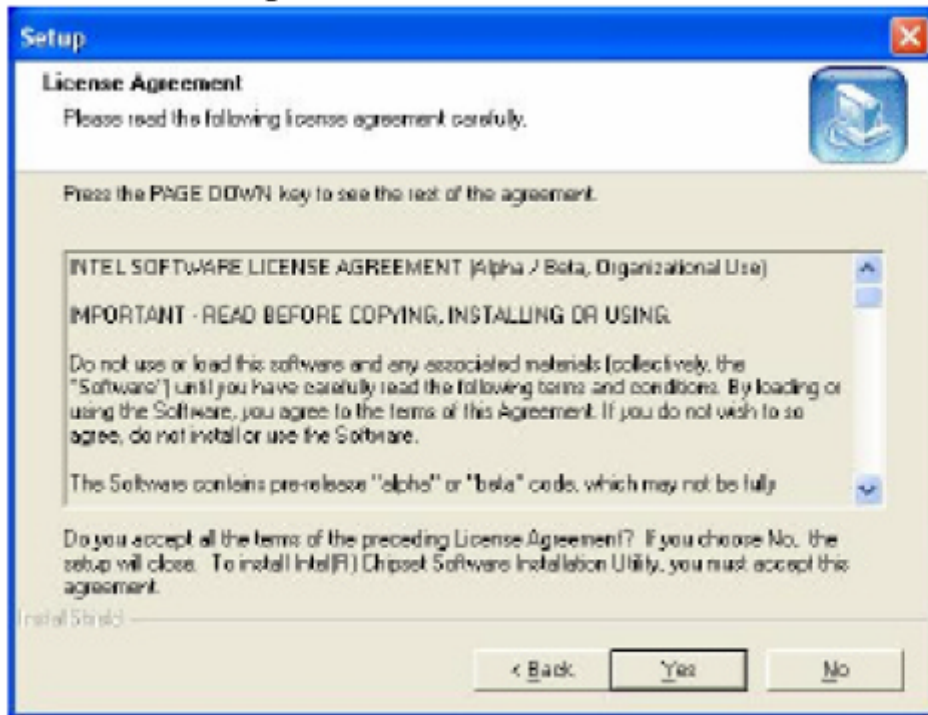

5. On Readme Information screen, click *Next* to continue the installation.

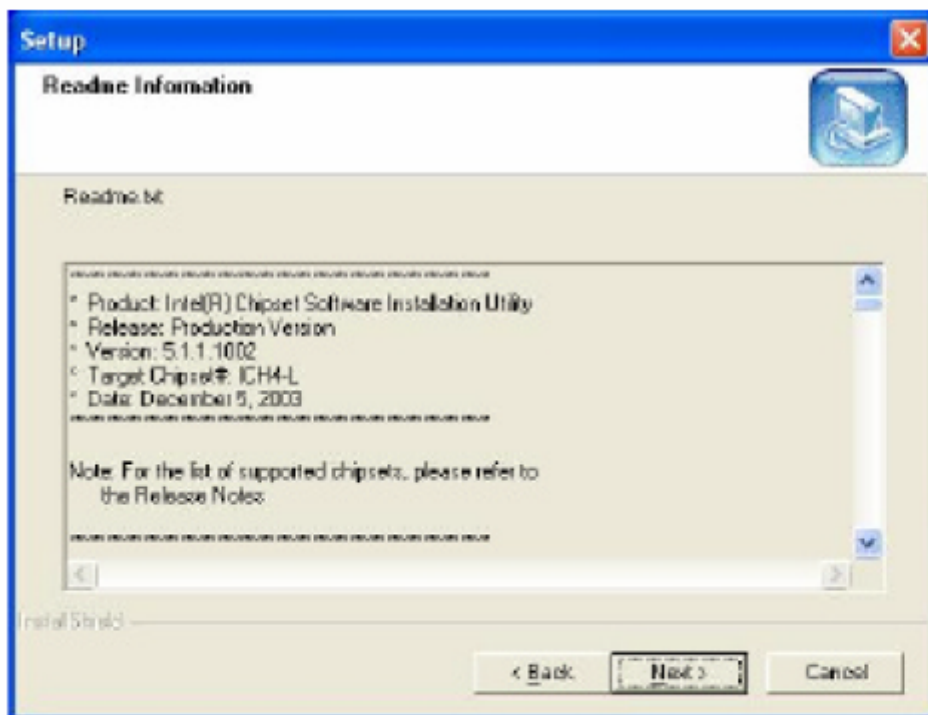

6. The Setup process is now complete. Click *Finish* to restart the computer and for changes to take effect. When the computer has restarted, the system will be able to find some devices. Restart your computer when prompted.

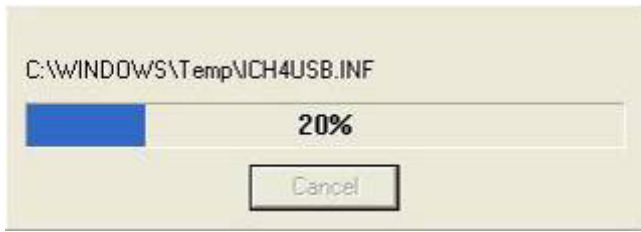

VGA Driver installation

To install the VGA Driver follow the steps below to proceed with the installation.

Step 1. Insert the TopsCCC product CD That comes with the board.

Step 2. Click “ Intel® VGA 855GME Chipset “

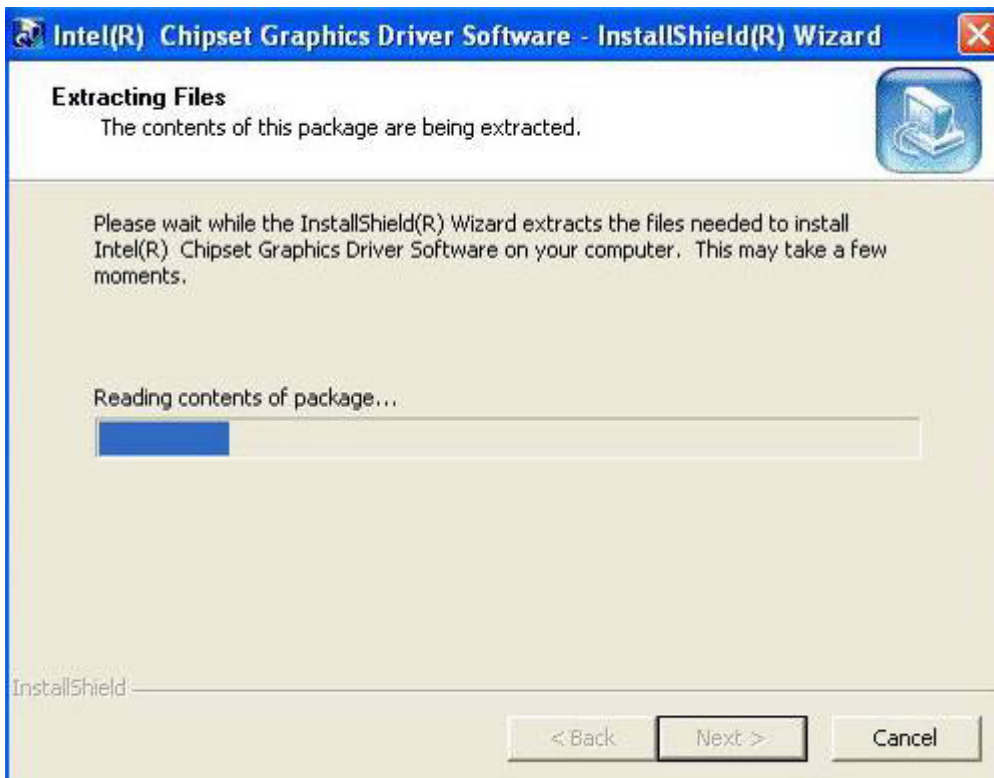
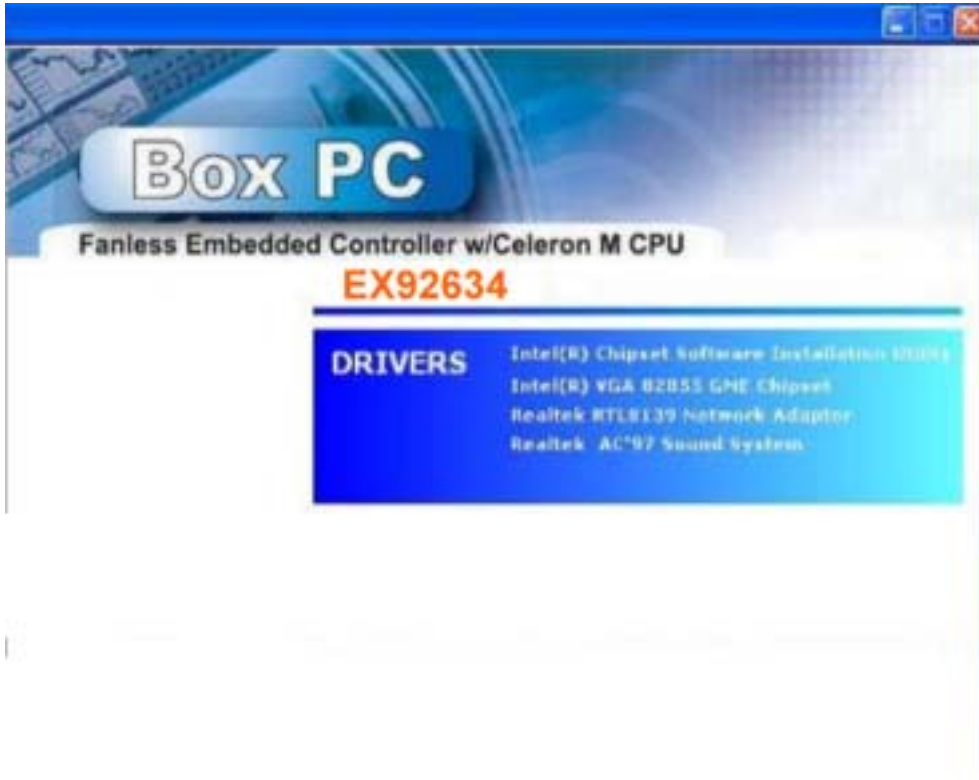

Step 3. When the Welcome screen appears , click “**Next**” to continue.



Step 4. Click **YES** to agree with the license agreement and continue the installation.

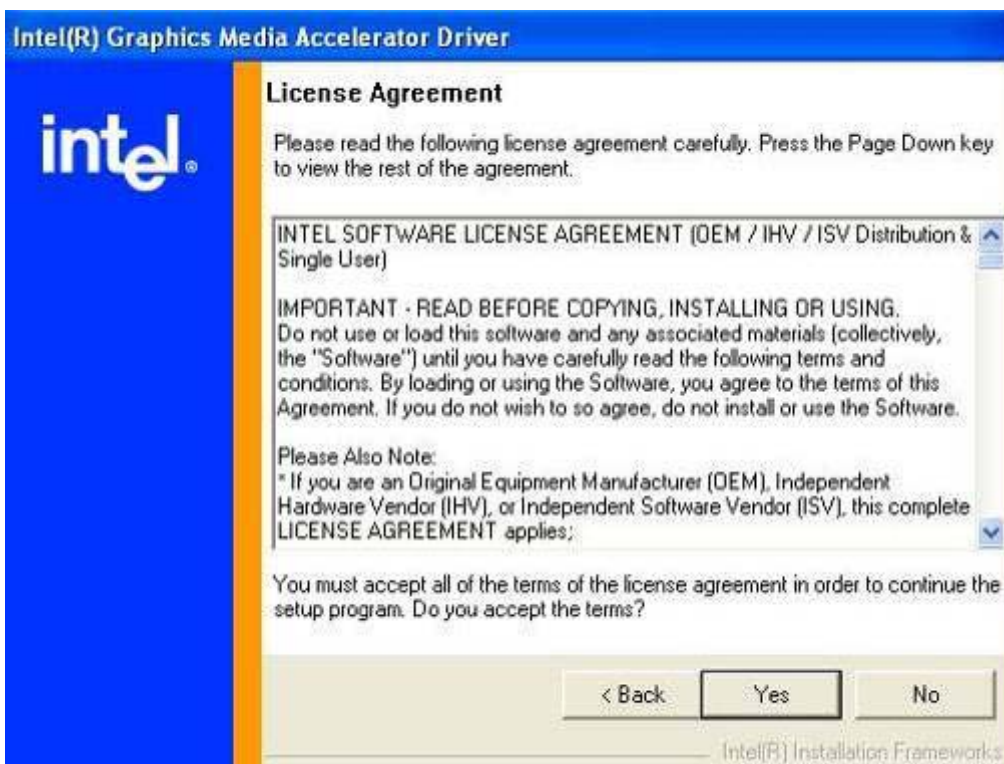

Step 5. The Setup process is now complete. Click Finish to restart the computer as promoted and for changes to take effect. When the computer has restarted, the system will be able to find some devices. Restart your computer when prompted.

Installing version 6.14.10.4497....



Intel PRO LAN Drivers installation

Follow the steps below to complete the installation of the Intel PRO LAN drivers.

Step 1. Insert the TopsCCC product CD That comes with the board.

Step 2. Click “Intel® Network Adapter “

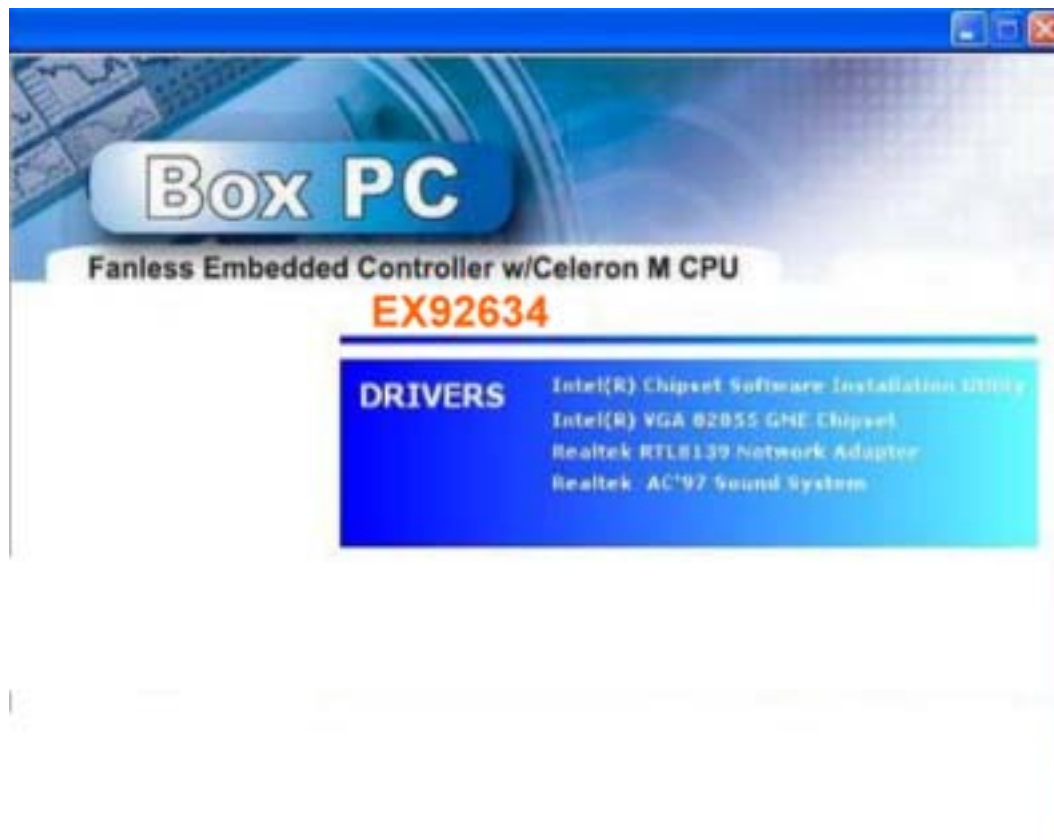

Step 3. When the Welcome screen appears , click “Next” to continue.

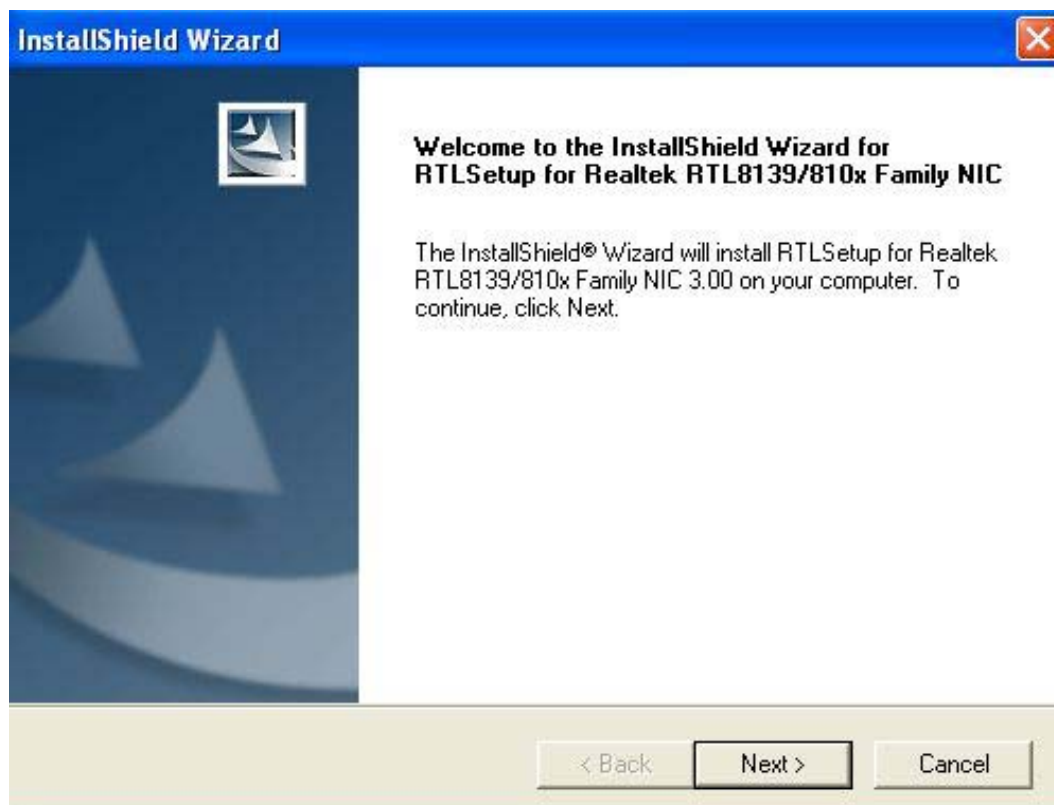

Step 4. Click **“Finish”** to restart the computer and for changes to take effect

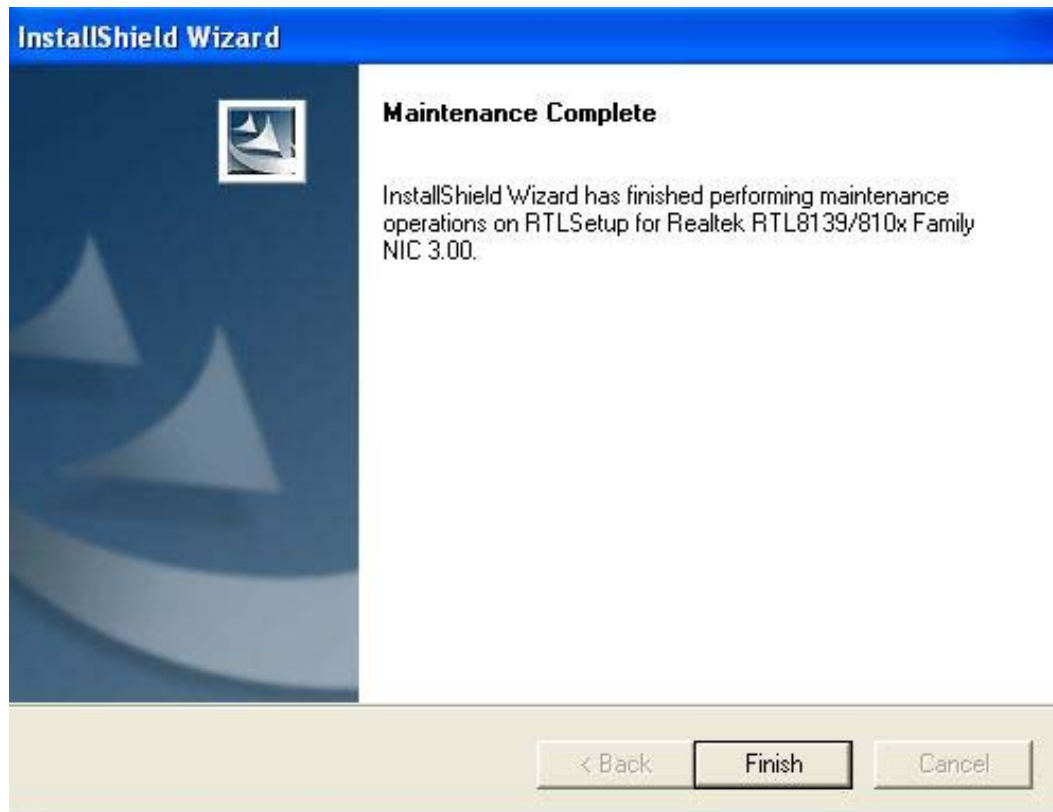

AC97 Codec Audio Driver installation

To install the Realtek AC97 codec Driver follow the steps below to proceed with the installation.

Step 1. Insert the TopsCCC product CD That comes with the board.

Step 2. Click “**Realtek AC97 ‘ Sound system ‘** “

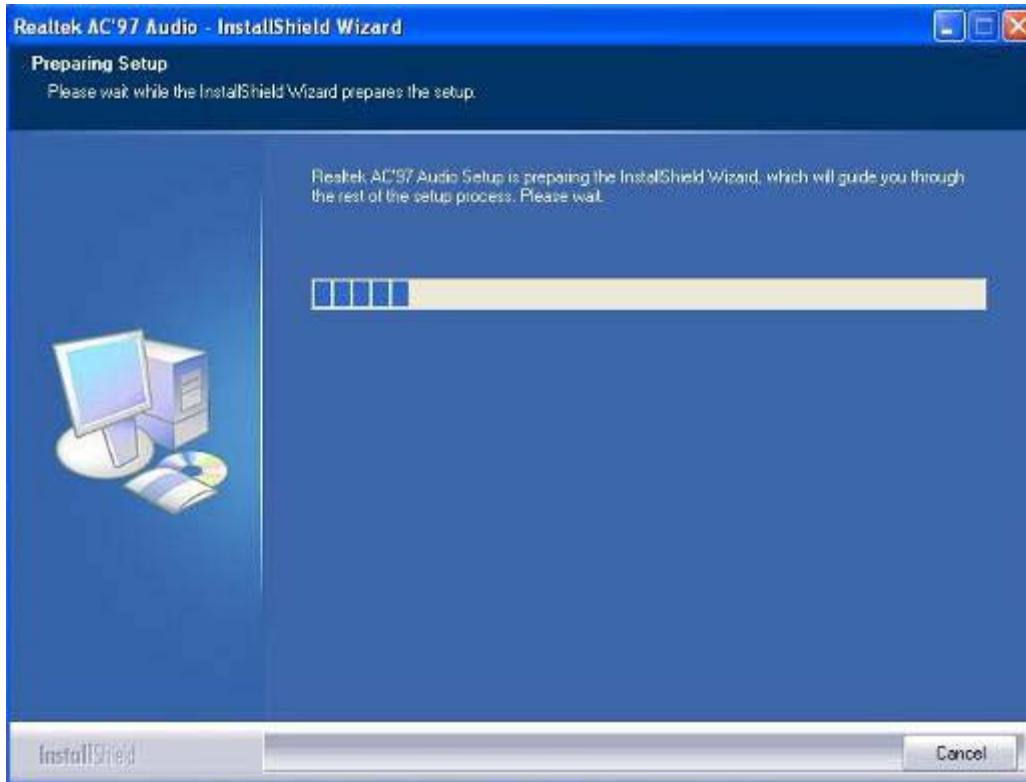

Step 3. When the Welcome screen appears , click “**Next**” to continue.

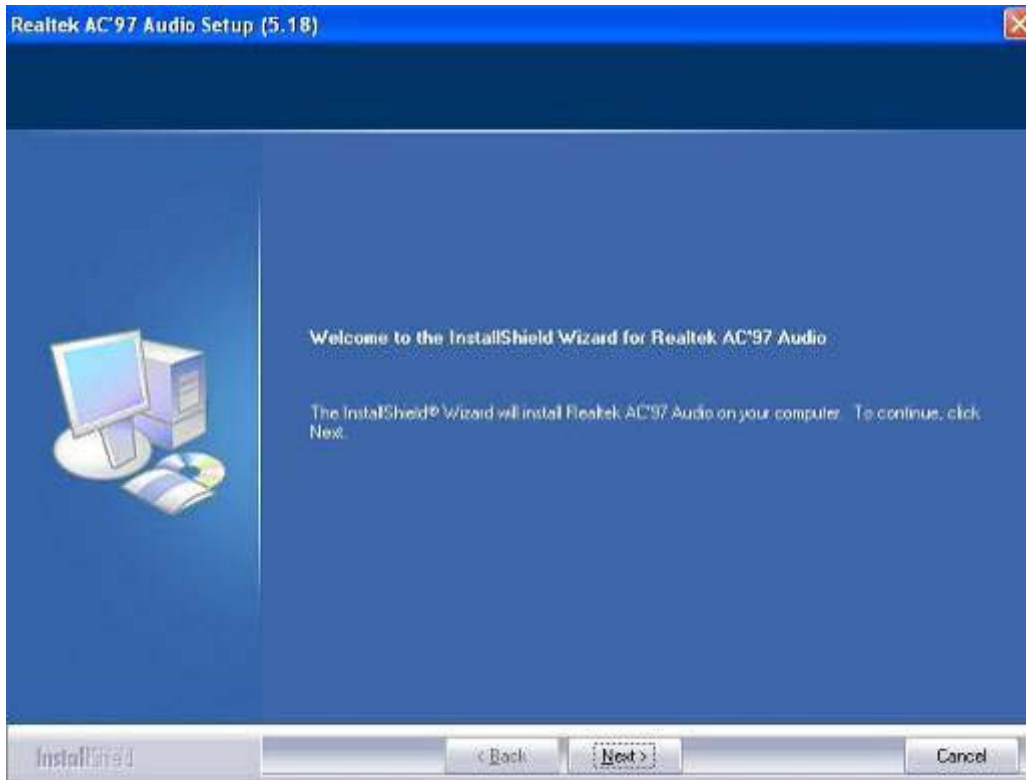

Step 4. Click **“Finish”** to restart the computer and for changes to take effect.

