

1.1 Introduction of EX9024H-M

EX9024H-M is a 4-channel analog output module with mixed type I/O. Under some circumstances, it is, however, a demand for multiple analog outputs to fulfill particular applications without many duplicate modules. EX9024H-M is designed to achieve this purpose by integrating four A/O channels and four isolated D/I channels into only one module. The four digital input channels function as an interlock for emergency latch output. The LED indicators are used for status reading and both ASCII and Modbus-RTU protocols are supported.

EX9024H-M provide multi-range A/O support, allows its four A/O channels working at the same time with different and more output ranges. For example, it can have 0~20 mA and ± 10 V at its output. To ensure the operation of machines and facilities, EX9024H-M has the functionality of slew rate control. Output slope is programmable through ramping/clamping the slew rate. Unlike traditional mechanism, EX9024H-M permits users to substitute its default value at the start up. Users can easily set up and configure the module to be more adaptive.

Specifications:

Support Protocol: ASCII and MODBUS-RTU

Interface: RS-485, 2 wires

Speed (bps): 1200, 2400, 4800, 9600, 19.2K, 38.4K , 115.2K

Analog output :

Output type: mA, V

Analog Channels Numbers: 4

Analog Resolution: 14 bits

Output Range: 0~20 mA, 4~20 mA, 0~+5V, ±5V, 0~+10V and ±10V

**Programmable Output Slope : 0.125 to 2048 mA/Second
0.0625 to 1024 V/Second**

Current Load Resistor: External 24V/1050 ohms

Accuracy : ±0.1% of FSR for current output

±0.2% of FSR for voltage output

Zero Drift: Voltage output : ±30μV/°C

Current output : ±0.2μA/°C

Span Temperature Coefficient: ±25 ppm/°C

Isolation voltage : 3000VDC

Isolation Digital Input:

Channel: 4(Sigle Ended w/ Common Source)

Logical level 0: +1V max.

Logical level 1: +10 ~ +30Vdc

Isolation voltage : 3750Vrms

Watchdog Function:

Host programmable watchdog: 100 ms ~ 25.500 sec

Overvoltage protection: ±35V

Power input : +10V to +30VDC

Consumption: 2.4W

1.2 Pin Assignment



1.3 Block Diagram

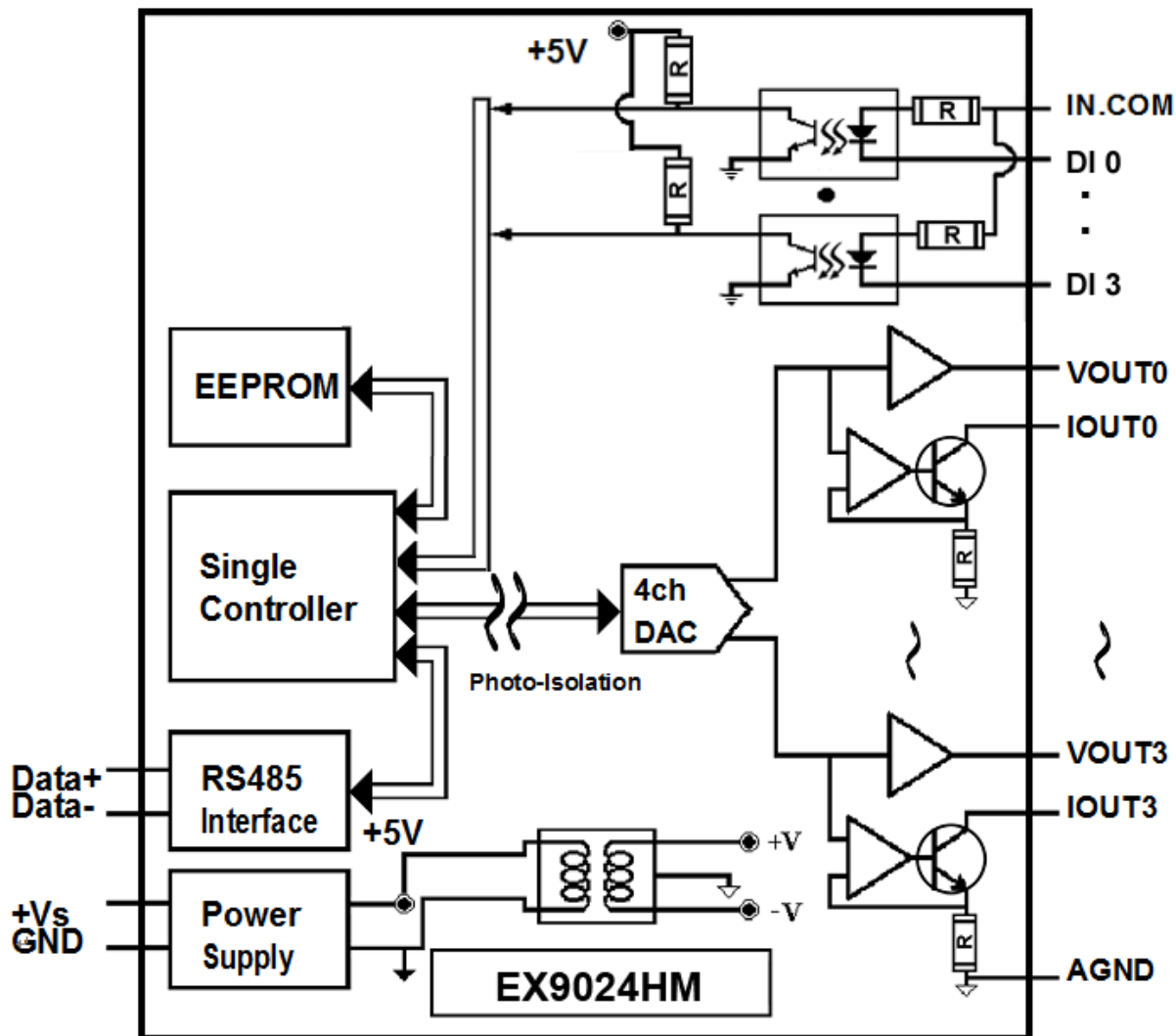

1.4 Wire Connection

Voltage output wire connection

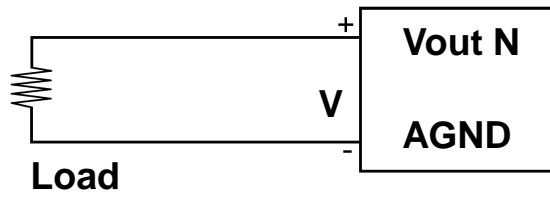

Current output wire connection

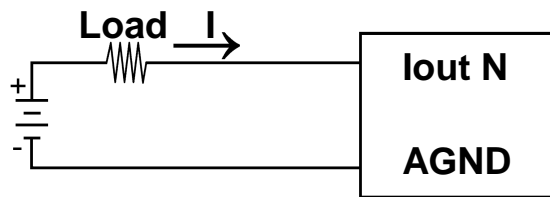

Note : External Power setting, may drive load up to **1050 ohms**.

Isolation digital input wire connection

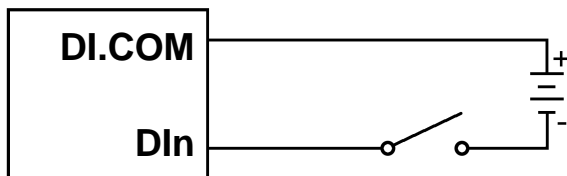

1.5 Default Setting for EX9024H-M

Address:01

Analog O/P Type: 0 ~ +10V

Analog O/P slew rate: Immediate change

Baudrate : 9600bps

Checksum: disable

Protocol: Modbus

1.6 INIT* Mode Operation

Each EX9000 module has a build-in EEPROM to store configuration information such as address, type, baudrate and other information. Sometimes, user may forget the configuration of the module. Therefore, the EX9000 have a special mode named "INIT* mode" to help user to resolve the problem. The "INIT* mode" is setting as Address=00, Baudrate=9600bps, no Checksum .

Originally, the INIT* mode is accessed by connecting the INIT* terminal to the GND terminal. New EX9000 modules have the INIT* switch located on the rear side of the module to allow easier access to the INIT* mode. For these modules, INIT* mode is accessed by sliding the INIT* switch to the Init position as shown below.

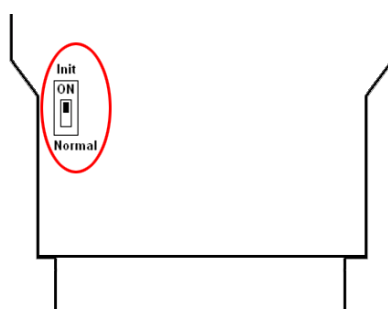

To enable INIT* mode, please following these steps:

Step1. Power off the module

Step2. Connect the INIT* pin with the GND pin.

(or sliding the INIT* switch to the Init* ON position)

Step3. Power on

Step4. Send command \$002 (cr) in 9600bps to read the Configuration stored in the module's EEPROM.

There are commands that require the module to be in INIT* mode. They are:

1. %AANN TTCCFF when changing the Baud Rate and checksum settings. See Section 3.20.1 for details.
2. \$AAPN, See Section 3.20.8 for details.

1.7 Module Status for DIO, AIO

Power On Reset or **Module Watchdog Reset** will let all output goto **Power On Value**. And the module may accept the host's command to change the output value.

Host Watchdog Timeout will let all output goto **Safe Value**. The module's status(read by command~AA0) will be 04, and the output command will be ignored.

1.8 Dual Watchdog Operation for DIO, AIO

Dual Watchdog=Module Watchdog + Host Watchdog

The Module Watchdog is a hardware reset circuit to monitor the module's operating status. While working in harsh or noisy environment, the module may be down by the external signal. The circuit may let the module to work continues and never halt.

The Host Watchdog is a software function to monitor the host's operating status. Its purpose is to prevent the network from communication problem or host halt. When the timeout interval expired, the module will turn all outputs to predefined Safe Value. This can prevent the controlled target from unexpected situation.

The EX9000 module with Dual Watchdog may let the control system more reliable and stable.

1.9 Reset Status

The Reset Status is set while the module power on or reset by module watchdog and is cleared while the command read Reset Status (\$AA5) applied. This is useful for user to check the module's working status. When the Reset Status is set means the module is reset and the output may be changed to the PowerOn Value. When the Reset Status is clear means the module is not rested and the output is not changed.

1.10 Digital O/P

The module's output have 3 different situation :

<1>**Safe Value.** If the host watchdog timeout status is set, the output is set to Safe Value. While the module receive the output command like @AA(Date) or #AABBDD, the module will ignore the command and return "!". And will not change the output to the output command value. **The host watchdog timeout status is set and store into EEPROM while the host watchdog timeout interval expired and only can be cleared by command ~AA1.** If user want to change the output it need to clear the host watchdog timeout status firstly and send output command to change the output into desired value.

<2>**PowerOn Value.** Only the module reset and the host watchdog timeout status is clear, the module's output is set to predefined Power On Value.

<3> **Output Command Value.** If the host watchdog timeout status is clear and user issue a digital output command like @AA (Data) or #AABBDD to module for changing the output value. The module will response success (receive>).

1.11 Latch Digital I/P

For example, use connect the key switch to Digital input channel of a digital input/output module and want to read the key stroke. The Key input is a pulse digital input and user will lost the strike. While reading by command \$AA6 in A and B position, the response is that no key stroke and it will lose the key stroke information. Respectely, the read latch low digital input command \$AAL0 will solve this problem. When issue \$AAL0 command in A and B position, the response denote that there is a low pulse between A and B position for a key stroke.



1.12 Calibration

The current calibration procedure is as follows :

1. Connect meter and external power source to module's current output channel N.

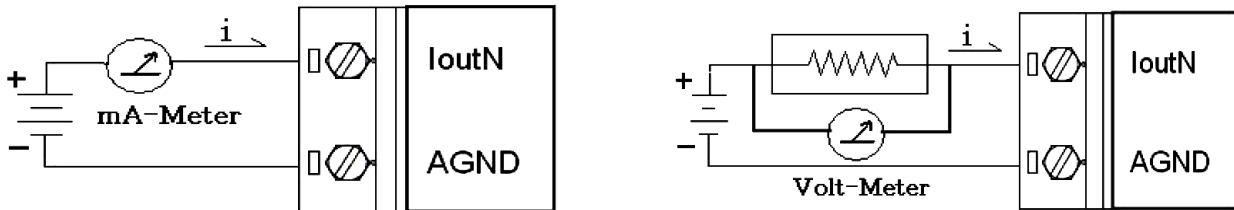

2. Warm up the module for 30 minutes.
3. Setting type to 30 (0 to 20mA) by command "\$AA9NTTSS" (see p22)
4. Output 0mA by analog output command "#AAN(data)" (see p13)
5. Check the meter and trim the output until 0mA match by apply trim command "\$AA3NVV" (see p44)
6. Repeat step(5) for trim calibration.
7. Perform 0mA calibration command for save min. calibration parameter. by command "\$AA0N" (see p14)
8. Output 20mA by analog output command "#AAN(data)" (see p13)
9. Check the meter and trim the output until 20mA match by apply trim command "\$AA3NVV" (see p16)
10. Repeat step(9) for trim calibration.
11. Perform 20mA calibration command for save min. calibration parameter. by command "\$AA1N" (see p15)
12. Repeat steps 4 to 11 three times.

Warning: Please don't calibrate before you really understand.

The voltage calibration procedure is as follows :

1. Connect meter to module's Voltage output channel N.

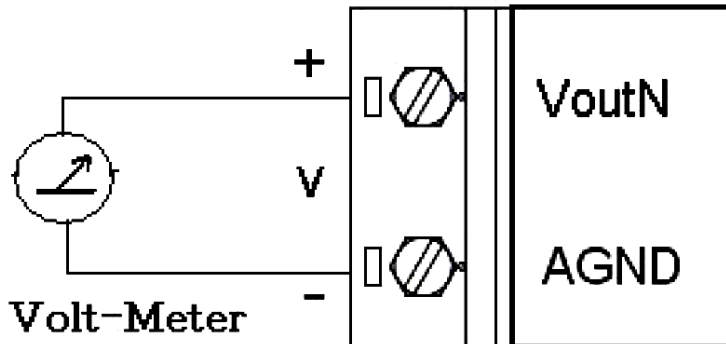

2. Warm up the module for 30 minutes.
3. Setting type to 33 (-10V to +10V) by command "\$AA9NTTSS" (see p22)
4. Output -10V by analog output command "#AAN(data)" (see p13)
5. Check the meter and trim the output until -10V match by apply trim command "\$AA3NVV" (see p16)
6. Repeat step(5) for trim calibration.
7. Perform -10V calibration command for save min. calibration parameter. by command "\$AA0N" (see p14)
8. Output +10V by analog output command "#AAN(data)" (see p13)
9. Check the meter and trim the output until +10V match by apply trim command "\$AA3NVV" (see p16)
10. Repeat step(9) for trim calibration.
11. Perform +10V calibration command for save min. calibration parameter by command "\$AA1N" (see p15)
12. Repeat steps 4 to 11 three times.

Warning: Please don't calibrate before you really understand.

2. Configuration Table

Analog O/P type code setting(TT)

TT	Rang	Format	MAX	MIN	Output Resolution
30	0 ~ 20 mA	Engineer Unit	+20.000	+00.000	2.4414 μ A
		Hexadecimal	3FFF	0	1.2207 μ A
31	4 ~ 20 mA	Engineer Unit	+20.000	+04.000	2.4414 μ A
		Hexadecimal	3FFF	0	0.9766 μ A
32	0 ~ 10 V	Engineer Unit	+10.000	+00.000	1.2207mV
		Hexadecimal	3FFF	0	0.6104mV
33	-10 ~ +10 V	Engineer Unit	+10.000	-100.000	1.2207mV
		Hexadecimal	3FFF	C000	0.6104mV
34	0 ~ +5 V	Engineer Unit	+05.000	+00.000	1.2207mV
		Hexadecimal	3FFF	0	0.3052mV
35	-5 ~ +5 V	Engineer Unit	+05.000	-05.000	1.2207mV
		Hexadecimal	3FFF	C000	0.3052mV

Note: Hexadecimal format only for Modbus RTU mode

Engineer Unit format only for ASCII command mode

Baudrate Setting(CC)

CC	Baud Rate
03	1200 BPS
04	2400 BPS
05	4800 BPS
06	9600 BPS
07	19200 BPS
08	38400 BPS
09	57600 BPS
0A	115200 BPS

Data Format(FF)

7	6	5	4	3	2	1	0
Set to 0	Checksum (CRC in Modbus) 0=disable 1=enable	Slew Rate Control set to 0000 Slew Rate Control ref. sec. 4.1				00:engineeringunit	

Slew Rate Control(SS)

Slew rate	V/Sec.	mA/Sec.
00	Immediate	
01	0.0625	0.125
02	0.125	0.25
03	0.25	0.5
04	0.5	1.0
05	1.0	2.0
06	2.0	4.0
07	4.0	8.0
08	8.0	16.0
09	16.0	32.0
0A	32.0	64.0
0B	64.0	128.0
0C	128.0	256.0
0D	256.0	512.0
0E	512.0	1024.0
0F	1024.0	2048.0

3. ASCII Command

3.1 #AAN(data)

Description: Output Analog Value for Channel N

Syntax: #AAN(data)[CHK](cr)

delimiter character

AA address of reading/response module(00 to FF)

(data): Analog Output Value

N=Channel No. (from 0 to 3)(data)

Response: Valid Command: >

Out of range: ?AA

Command ignore: !

Example:

Command: #010+12.345 Receive: >

Module address 01, Channel 0 Current output : 12.345mA

Command: #023-02.500 Receive: >

Module address 02, Channel 3 voltage output: -2.5V

Command: #020+30.000 Receive: ?02

Out of range and output value will go to the most close value

3.2 \$AA0N

Description: Perform -10V/0mA calibration for channel N.

Syntax: \$AA0N[CHK](cr)

\$ delimiter character

AA address of reading/response module(00 to FF)

0 command for perform 4mA (or 0mA/-10V) calibration

N=Channel No. (0 to 3)

Response: Valid Command: !AA

Invalid Command: ?AA

Example:

Command: \$0201 Receive: !02

Module address 02, Channel 1, perform -10V/0mA for EX9024H-M calibration.

Warning: Please don't calibrate before you really understand.

3.3 \$AA1N

Description: Perform +10V/20mA calibration for channel N

Syntax: \$AA1N[CHK](cr)

\$ delimiter character

AA address of reading/response module(00 to FF)

1 command for performing 20mA/+10V calibration

N channel to calibration (0 to 3)

Response: Valid Command: !AA

Invalid Command: ?AA

Example

Command: \$0112 Receive: !01

Module address 01, channel 2, perform +10V/20mA calibration

Command: \$2010 Receive: !02

Module address 02, channel 0, perform +10V/20mA calibration.

Warning: Please don't calibrate before you really understand.

3.4 \$AA3NVV

Description: Trim the analog output for calibration for channel N.

Syntax: \$AA3NVV[CHK](cr)

\$ delimiter character
AA address of reading/response module(00 to FF)
3 command for trimming calibration
N channel to trim (0 to 3)
VV 2' complement hexadecimal to trim the analog output value,
00 to 5F: increase analog output 0 to 95 counts
FF to A1: decrease analog output 1 to 95 counts
Each count indicates 2.44uA or 1.22mV

Response: Valid Command: !AA
Invalid Command: ?AA

Example:

Command: \$013202 Receive: !01

For channel 2, to increase analog output 2 count=2*2.44 uA or 2*1.22 mV, depend on output type.

Warning: Please don't calibrate before you really understand.

3.5 \$AA4N

Description: Set Power-on value for channel N.

Syntax: \$AA4N[CHK](cr)

\$ delimiter character

AA address of reading/response module(00 to FF)

4 command for set the output value to Power-on value

N channel to set Power-on value (0 to 3)

Response: Valid Command: !AA

Invalid Command: ?AA

Example:

Command: #020-01.234 Receive: >

Channel 0 analog output -1.234V

Command: \$0240 Receive: !02

To set the Power-on value for channel 0 as -1.234V

3.6 \$AA6N

Description: Last value Readback of Channel N

Syntax: \$AA6N[CHK](cr)

\$ delimiter character

AA address of reading/response module(00 to FF)

6 command for read last output command value

N Channel to readback (0 to 3)

Response: Valid Command: !AA(Data)

Invalid Command: ?AA

(Data) the last output command value. If no output applied to the module that the (data) is the Power-on value of the module

Example:

Command: #010+12.345 Receive:>

The analog output for channel 0 is 12.345mA

Command: \$0160 Receive: !010+12.345

Last output command value 12.345mA

3.7 \$AA7N

Description: Read the power-on output value of channel N.

Syntax: \$AA7N[CHK](cr)

\$ delimiter character

AA address of reading/response module(00 to FF)

7 command for read power-on value

N channel to readback (0 to 3)

Response: Valid Command: !AA(Data)

Invalid Command: ?AA

(Data) the last output command value

Example:

Command: #020-01.234 Receive: >

Channel 0 analog output -1.234V

Command: \$0240 Receive: !02

To set power-on value for channel 0 as -1.234V

Command: #020-03.456 Receive: >

Channel 0 analog output -3.456V

Command: \$0270 Receive: !02-01.234

The read power-on value of channel 0 is -1.234V

Command: \$0260 Receive: !02-03.456

The last output value of channel 0 is -3.456V

3.8 \$AA8N

Description: Current Value Readback of Channel N .

When sending a command to assign the analog output value for a specific channel of EX9024H-M. The analog output is updated gradually at the specific slew rate until the desired output value is reached. This command can read the analog value during updating process.

Syntax: \$AA8N[CHK](cr)

\$ delimiter character

AA address of reading/response module(00 to FF)

7 command for read Current Value Readback of Channel N

N channel to readback (0 to 3)

Response: Valid Command: !AA(Data)

Invalid Command: ?AA

(Data) the last output command value

Example:

Command: \$012 Receive: !0132060C

The configuration for this EX9024H-M as follows:

Output range: 0 to 10V, slew rate: 0.25V/sec

Checksum: Disable

Command: #010+01.000 Receive:>

Set channel 0 output value to 1.000V

Command: #010+09.800 Receive:>

Set channel 0 output value to 9.800V

Command: \$0180 Receive:!01+01.372

Read back value is 1.372V

Command: \$0180 Receive:!01+04.821

The reading back value is 4.821V

Command: \$0180 Receive:!01+06.772

The reading back value is 6.772V

Command: \$0180 Receive:!01+08.291

The reading back value is 8.291V

Command: \$0180 Receive: !01+09.800

The reading back value is 9.800V

3.9 \$AA9N

Description: Read DA Configuration of Channel N

Syntax: \$AA9N[CHK](cr)

\$ delimiter character

AA address of reading/response module(00 to FF)

8 command for read DA configuration of channel N

N channel to read DA configuration (0 to 3)

Response: Valid Command: !AATTSS

Invalid Command: ?AA

the last output command value

TT analog output Type ref. sec. 2 for format

SS analog output Slew rate ref. sec. 2 for format

Example:

Command: \$0190 Receive: !013000

Read address 01 channel 0 DA configuration & 0 to 20mA output Type and change immediate .

3.10 \$AA9NTTSS

Description: Set DA Configuration of Channel N

Syntax: \$AA9NTS[CHK](cr)

\$ delimiter character

AA address of reading/response module(00 to FF)

9 command for set DA configuration

N channel to set DA configuration (0 to 1)

TT analog output Type ref. sec. 2 for format

SS analog output Slew rate ref. sec. 2 for format

Response: Valid Command: !AA

Invalid Command: ?AA

Example:

Command: \$01913301 Receive: !01

Set address 01 channel 1 DA configuration & 0 to 10V output Type and Slew rate 0.0625 V/Second .

3.11 ~AA4N

Description: Read the safe value of channel N.

Syntax: ~AA4N[CHK](cr)

~ delimiter character

AA address of reading/response module(00 to FF)

4 command for read Safe Value

N channel to read (0 to 3)

Response: Valid Command: !AA(Data)

Invalid Command: ?AA

(Data) Save Value of module

Example:

Command: ~0140 Receive: !01+02.000

The safe value of channel 0 is 2.000V

Command: ~0141 Receive: !01+01.234

The safe value of channel 1 is 1.234V

3.12 ~AA5N

Description: Set Safe Value of Channel N.

Syntax: ~AA5N[CHK](cr)

~ delimiter character

AA address of reading/response module(00 to FF)

5 command for store current output value as Safe Value

N channel to set (0 to 3)

Response: Valid Command: !**AA(Data)**

 Invalid Command: ?**AA**

Example:

Command: #010+12.345 Receive: !01

 Output channel 0 address 01 value as +12.345mA

Command: ~0150 Receive: !01

 To set Safe Value of Channel 0 address 01 to 12.345mA

3.13 ~AA8NE

Description: Enable/Disable Emergency Input(DI).

Syntax: ~AA8NE[CHK](cr)

~ delimiter character
AA address of reading/response module(00 to FF)
8 command for set Emergency DI input
N channel to set (0 to 3)
E Disable/Enable emergency inputs (DI)
0 : Disable / 1 : Enable

Response: Valid Command: !AA
Invalid Command: ?AA

Note:

- (1) When a emergency input(DI) is active(low), the module will be forced to safety output state for channel N of A/O.
- (2) If disable is selected then emergency input(DI) same as standard digital input.

Example:

Command: #041+01.000 Response: >

Output address 04 value +01.000V for channel 1, return success.

Command: ~0451(cr) Response: !01

Set address 04 channel 1 Safe Value, return success.

Command: ~04181 (cr) Response: !04

Set module (ID=04) to enable channel(1) emergency inputs.

Command: ~040(cr) Response: !0410

Read module status from module (ID=04) and return the channel(1) emergency Input is enable.

wait.....

The modules emergency Input(DI) channel(1) is active(low) and the AO channel N of the module is into safe output mode.

;

Command: @040(cr) Response: !040D

Read Emergency Input port status from module (ID=04) and return the emergency input channel(1) is active(low).

Command: #041+01.000 Response: !

Output address 04 value +01.000V for channel 1, return emergency input is active and the output command will be ignored.

3.14 @AA

Description: Read Emergency digital input status.

Syntax: @AA[CHK](cr)

@ delimiter character

AA address of reading/response module(00 to FF)

Response: Valid Command: >00(Data)

Invalid Command: ?AA

Note: The Data are in two hexadecimal digitals format.

Module	Data	
EX9024H-M	DI0~DI3	00~07

Example:

Command: @01 Receive: >0005

Read address 01 digital input status and return DI(0,2) high level and DI(1,3) low level.

3.15 ~**

Description: Host OK.

Host send this command to all modules for send the information “Host OK”.

Syntax: ~**[CHK](cr)

~ delimiter character

** command for all modules

Response: No response

Example:

Command: ~** Receive: No response

Send Host OK to all modules.

3.16 ~AA0

Description: Read WDT Status & Emergency input flag.

Syntax: ~AA0[CHK](cr)

~ delimiter character

AA address of reading/response module(00 to FF)

0 command for read modules status

SS Module status (Hex)

7	6	5	4	3	2	1	0
WDT enable flag	DI3	DI2	DI1	DI0	WDT timeout	0	
Disable: 0 Enable: 1	Emergency input Enable/Disable flag, one channel per bit of bit(3~6) for channel(0~3) and status is indicated as: Disable:0, Enable:1				Clear: 0 Set: 1		

Note:

(1) the watchdog timeout status will be stored in EEPROM of the module and can only be cleared by issuing ~AA1 command.

(2) the emergency input(DI) enable/disable flag will be stored in EEPROM of the module and can only be set by issuing ~AA8NE command.

Response: Valid Command: !AASS

Invalid Command: ?AA

3.17 ~AA1

Description: Reset Module Status.

Syntax: ~AA1[CHK](cr)

~ delimiter character

AA address of reading/response module(00 to FF)

1 command for reset modules status

Response: Valid Command: !AA

Invalid Command: ?AA

3.18 ~AA2

Description: Read Host Watchdog Timeout Value

Syntax: ~AA2[CHK](cr)

~ delimiter character

AA address of reading/response module(00 to FF)

2 command for read host watchdog timeout value

Response: Valid Command: !AAEVV

Invalid Command: ?AA

E Host watchdog enable status, 1=Enable, 0=Disable.

VV Timeout value in HEX format, Each count is 0.1 second, 01=0.1 second and FF=25.5 seconds.

3.19 ~AA3E VV

Description: Set host watchdog Timeout value

Syntax: ~AA3E VV[CHK](cr)

~ delimiter character

AA address of reading/response module(00 to FF)

3 command for set host watchdog timeout value

E 1=Enable/0=Disable host watchdog

VV timeout value, from 01 to FF, each for 0.1 second

Response: Valid Command: !AA

Invalid Command: ?AA

Example:

Command: ~010 Receive: !0100

Read address 01 modules status, return host watchdog timeout status is clear.

Command: ~013164 Receive: !01

Set address 01 host watchdog timeout value 10.0 seconds and enable host watchdog, return success.

Command: ~012 Receive: !01164

Read address 01 host watchdog timeout value, return that host watchdog is enabled, and time interval is 10.0 seconds.

Command: ~** No response

Reset the host watchdog timer.

Wait for about 10 seconds and don't send command ~**, the LED of module will go to flash. The flash LED indicates the host watchdog timeout status is set.

Command: ~010 Receive: !0104

Read address 01 module status, return host watchdog timeout status is set.

Command: ~012 Receive: !01064

Read address 01 host watchdog timeout value, return that host watchdog is disabled, and time intervals is 10.0 seconds.

Command: ~011 Receive: !01

Reset address 01 host watchdog timeout status, return success and the LED of this module stop flash.

Command: ~010

Read address 01 module status, return host watchdog timeout status is clear.

3.20 General Command Sets

3.20.1 %AANNTTCCFF

Description: Set Module Configuration

Syntax: %AANNTTCCFF[CHK](cr)

% delimiter character

AA address of reading/response module(00 to FF)

NN new address for setting response module(00 to FF)

TT new type for setting module (sec. 2 for format)

CC new baudrate for setting module. (sec. 2)

It is needed to short the INIT* to ground while change baudrate.

FF new data format for setting module. (sec. 2 for format)

It is needed to short the INIT* to ground to change checksum setting.

Response: Valid Command: !AA

Invalid Command: ?AA

Example:

Command: %0102300600 Receive: !02

Set module address 01 to 02,

Analog output type: 0 to 20mA

Baudrate: 9600bps

Dataformat: No checksum, Engineer unit, slew rate is immediate

return success.

3.20.2 \$AA2

Description: Read Configuration

Syntax: \$AA2[CHK](cr)

\$ delimiter character

AA address of reading/response module(00 to FF)

2 command for read configuration

Response: Valid Command: !AATTCCFF

Invalid Command: ?AA

TT type code of module (sec. 2 for format)

CC baudrate code of module (sec. 2 for format)

FF data format of module (sec. 2 for format)

Example:

Command: \$012 Receive: !01306000

Read address 01 status, return

Analog output type: 0 to 20mA

Baudrate: 9600bps

Dataformat: No checksum, Engineer unit, slew rate is immediate

3.20.3 \$AA5

Description: Read Reset Status

Syntax: \$AA5[CHK](cr)

\$ delimiter character

AA address of reading/response module(00 to FF)

5 command for read reset status

Response: Valid Command: !AAS

Invalid Command: ?AA

S reset status, 1= the module is been reset,
0= the module is not been reseted

Example:

Command: \$015 Receive: !011

Read address 01 reset status, return first read.

Command: \$015 Receive: !010

Read address 01 reset status, return no reset occurred.

3.20.4 \$AAF

Description: Read Firmware Version

Syntax: \$AAF[CHK](cr)

\$ delimiter character

AA address of reading/response module(00 to FF)

F command for read firmware version

Response: Valid Command: !AA(Data)

Invalid Command: ?AA

(Data) firmware version of module

Example:

Command: \$01F Receive: !01R1.4

Read address 01 firmware version, return version R1.4.

Command: \$02F Receive: !01A1.4

Read address 02 firmware version, return version A1.4.

3.20.5 \$AAM

Description: Read Module Name

Syntax: \$AAM[CHK](cr)

\$ delimiter character

AA address of reading/response module(00 to FF)

M command for read module name

Response: Valid Command: !AA(Data)

Invalid Command: ?AA

(Data) Name of module

Example:

Command: \$01M Receive: !019021

Read address 01 module name, return name 9021.

Command: \$03M Receive: !029024

Read address 03 module name, return name 9024

3.20.6 ~AAO(Data)

Description: Set Module Name

Syntax: ~AAO(Data)[CHK](cr)

~ delimiter character

AA address of reading/response module(00 to FF)

O command for set module name

(Data) new name for module, max 6 characters

Response: Valid Command: !AA

Invalid Command: ?AA

Example:

Command: ~01O9024 Receive: !01

Set address 01 module name 9084, return success.

Command: \$01M Receive: !019024

Read address 01 module name, return name 9024

4.1 Slew Rate Control

Slew rate control is to adjust the O/P slope . Most analog O/P change is instantaneously . In many applications that this characteristics is undesirable and a gradual controlled output Slew rate is more appropriate.

The EX9024H-M allows programmable Slew rate control. While the O/P command is sent to EX9024H-M to change the analog value , the O/P will automatically slope to the new value at the special Slew rate .The EX9024H-M update the analog value at approximately 100 conversions per second . The O/P is smoothly stepped until the final O/P value is reached .

4.2 Current Readback

The EX9024H-M have the analog to digital converter to monitor the current O/P signal . The current Readback may find the fault of improper wiring or loads while thr Readback value is far from the O/P value .

The EX9024H-M don't have the analog to digital converter to monitor the current O/P signal . But the EX9024H-M may response the current digital value transferring to the Digital /Analog Converter . It can't indicate the real Digital / Analog Converter O/P value and can't detect the fault of improper wiring or loads .

EX9024H-M Modbus Quick Start

1. The default setting is MODBUS mode after Power On.

2. Sliding the INIT* switch to the Init*(ON) position of rear side then Power On will enter INIT* mode (use ASCII command).

Init* to GND

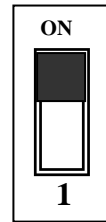

Normal

3. On ASCII command mode, user can set other setting like Address, Baudrate, ...by use ASCII command or Utility of EX9000 (Please check the User Manual of EX9000).

Note: If your application need with CRC check in modbus mode, please set the module to checksum(CRC) enable.

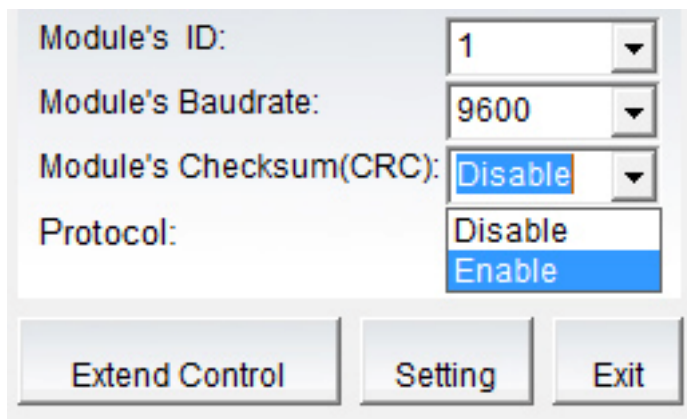

4. After change the setting finished, Sliding the INIT* switch to the Normal(1) position of rear side, the new setting will be effectived after the next power-on reset.

Init* to GND

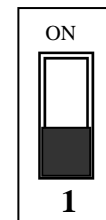

Normal

01(0x01) Read the protocol.

Request

00	Address	1 Byte	1-247
01	Function code	1 Byte	0x01
02~03	Starting channel	2 Bytes	0x0100
04~05	Channel numbers	2 Bytes	0x0001

Response

00	Address	1 Byte	1-247
01	Function code	1 Byte	0x01
02	Byte count	1 Byte	0x01
03	Protocol read back value	1 Byte	0x00=ASCII 0x01=Modbus RTU

05(0x05) Set the protocol.

Request

00	Address	1 Byte	1-247
01	Function code	1 Byte	0x05
02~03	Starting channel	2 Bytes	0x0100
04~05	Channel numbers	2 Bytes	0x0000=ASCII 0xFF00=Modbus RTU

Response

00	Address	1 Byte	1-247
01	Function code	1 Byte	0x05
02	Byte count	1 Byte	0x01
03	Protocol read back value	2 Byte	The value is the same as byte 04 and 05 of the Request

02(0x02) Read the emergency input of DI status

Request

00	Address	1 Byte	1-247
01	Function code	1 Byte	0x02
02~03	Starting channel	2 Bytes	0x0020~0x0023
04~05	Channel numbers	2 Bytes	0x0001~0x0004

Response

00	Address	1 Byte	1-247
01	Function code	1 Byte	0x02
02	Byte count	1 Byte	0x01
03	Emergency input channel read back value	1 Byte	0x00~0x0F A bit corresponds to a channel. When the bit is 1 it denotes that the value of the channel that was Input response. if the bit is 0 it denotes that the value of the channel that was no Input response .

03(0x03) Read the emergency input of DI status

Request

00	Address	1 Byte	1-247
01	Function code	1 Byte	0x03
02~03	Starting channel	2 Bytes	0x0020~0x0023
04~05	Channel numbers	2 Bytes	0x0001~0x0004

Response

00	Address	1 Byte	1-247
01	Function code	1 Byte	0x03
02	Byte count	1 Byte	0x01
03	Emergency input channel read back value	1 Byte	0x00~0x0F A bit corresponds to a channel. When the bit is 1 it denotes that the value of the channel that was Input response. if the bit is 0 it denotes that the value of the channel that was no Input response .

01(0x01) Read the emergency input of DI flag

Request

00	Address	1 Byte	1-247
01	Function code	1 Byte	0x01
02~03	Starting channel	2 Bytes	0x08C0~0x08C3
04~05	Channel numbers	2 Bytes	0x0001~0x0004

Response

00	Address	1 Byte	1-247
01	Function code	1 Byte	0x01
02	Byte count	1 Byte	0x01
03	Emergency input flag read back value	1 Byte	0x00~0x0F A bit corresponds to a channel. When the bit is 1 it denotes that the value of the channel that was Input response. if the bit is 0 it denotes that the value of the channel that was no Input response .

05(0x05) Set enable/disable the emergency input of DI flag (Single channel)

Request

00	Address	1 Byte	1-247
01	Function code	1 Byte	0x05
02~03	Channel number	2 Bytes	0x08C0~0x08C3
04~05	Channel value	2 Bytes	0xFF00 for enable 0x0000 for disable

Response

00	Address	1 Byte	1-247
01	Function code	1 Byte	0x05
02~03	Output channel numbers	2 Bytes	The value is the same as byte 02 and 03 of the Request
04~05	Output value	2 Bytes	The value is the same as byte 04 and 05 of the Request

15(0x0F) Set enable/disable the emergency input of DI flag (Multi channel)

Request

00	Address	1 Byte	1-247
01	Function code	1 Byte	0x0F
02~03	Starting channel	2 Bytes	0x08C0~0x08C3
04~05	Output channel numbers	2 Bytes	0x0001~0x0004
06	Byte count	1 Byte	1
07	Output value/Clear DI count value	1 Byte	0x00~0x0F A bit corresponds to a channel. When the bit is 1 it denotes that the value of the channel that was set is ON. if the bit is 0 it denotes that the value of the channel that was set is OFF.

Response

00	Address	1 Byte	1-247
01	Function code	1 Byte	0x0F
02~03	Starting channel	2 Bytes	The value is the same as byte 02 and 03 of the Request
04~05	Output channel numbers	2 Bytes	The value is the same as byte 04 and 05 of the Request

03(0x03) Read the output value of channel

(output value/power on value/ safe value/channel type/channel slew rate)

Request

00	Address	1 Byte	1-247
01	Function code	1 Byte	0x03
02~03	Starting channel	2 Bytes	0x0000~0x0003 for Output value 0x00C0~0x00C3 for Power on value 0x0BB8~0x0BBB for Safe value 0x0100~0x0103 for Output type 0x0120~0x0123 for Slew rate type
04~05	Channel numbers	2 Bytes	0x0001~0x0004

Response

00	Address	1 Byte	1-247
01	Function code	1 Byte	0x03
02	Byte count	1 Byte	N* x 2
03	Emergency input channel read back value	1 Byte	Refer the table as follow

N*=Number of output channels

Output type & Data Format Table

Type Code	Output Range	Data Format	Max.	Min.
0x0030	0 to 20mA	Hexadecimal	0x3FFF	0x0000
0x0031	4 to 20 mA	Hexadecimal	0x3FFF	0x0000
0x0032	0 to 10V	Hexadecimal	0x3FFF	0x0000
0x0033	-10V to +10V	Hexadecimal	0x3FFF	0xC000
0x0034	0 to +5V	Hexadecimal	0x2FFF	0x0000
0x0035	-5V to +5V	Hexadecimal	0x2FFF	0xC000

****Channel output value should be in hexadecimal form and should be between range of maximum & minimum value that depend on each type code.**

Slew rate table.

	0x0000	0x0001	0x0002	0x0003	0x0004	0x0005	0x0006	0x0007
V/sec	Immediate	0.0625	0.125	0.25	0.5	1.0	2.0	4.0
mA/sec		0.125	0.25	0.5	1.0	2.0	4.0	8.0

	0x0008	0x0009	0x000A	0x000B	0x000C	0x000D	0x000E	0x000E
V/sec	8.0	16.0	32.0	64.0	128.0	256.0	512.0	1024.0
mA/sec	16.0	32.0	64.0	128.0	256.0	512.0	10024.0	2048.0

**06(0x06) Write the output value of channel (single channel)
(output value/power on value/ safe value/channel type/channel slew rate)**

Request

00	Address	1 Byte	1-247
01	Function code	1 Byte	0x06
02~03	Starting channel	2 Bytes	0x0000~0x0003 for Output value 0x00C0~0x00C3 for Power on value 0x0BB8~0x0BBB for Safe value 0x0100~0x0103 for Output type 0x0120~0x0123 for Slew rate type
04~05	Output channel value	2 Bytes	Refer the table as follow

Response

00	Address	1 Byte	1-247
01	Function code	1 Byte	0x06
02	Starting channel	2 Byte	Same as byte 02 and 03 of the Request
03	Output channel value	2 Byte	Same as byte 04 and 05 of the Request

Output type & Data Format Table

Type Code	Output Range	Data Format	Max.	Min.
0x0030	0 to 20mA	Hexadecimal	0x3FFF	0x0000
0x0031	4 to 20 mA	Hexadecimal	0x3FFF	0x0000
0x0032	0 to 10V	Hexadecimal	0x3FFF	0x0000
0x0033	-10V to +10V	Hexadecimal	0x3FFF	0xC000
0x0034	0 to +5V	Hexadecimal	0x2FFF	0x0000
0x0035	-5V to +5V	Hexadecimal	0x2FFF	0xC000

****Channel output value should be in hexadecimal form and should be between range of maximum & minimum value that depend on each type code.**

Slew rate table.

	0x0000	0x0001	0x0002	0x0003	0x0004	0x0005	0x0006	0x0007
V/sec	Immediate	0.0625	0.125	0.25	0.5	1.0	2.0	4.0
mA/sec		0.125	0.25	0.5	1.0	2.0	4.0	8.0

	0x0008	0x0009	0x000A	0x000B	0x000C	0x000D	0x000E	0x000E
V/sec	8.0	16.0	32.0	64.0	128.0	256.0	512.0	1024.0
mA/sec	16.0	32.0	64.0	128.0	256.0	512.0	10024.0	2048.0

**16(0x10) Write the output value of channel (Multiple channel)
(output value/power on value/ safe value/channel type/channel slew rate)**

Request

00	Address	1 Byte	1-247
01	Function code	1 Byte	0x10
02~03	Starting channel	2 Bytes	0x0000~0x0003 for Output value 0x00C0~0x00C3 for Power on value 0x0BB8~0x0BBB for Safe value 0x0100~0x0103 for Output type 0x0120~0x0123 for Slew rate type
04~05	Output channel numbers	2 Bytes	0x0000~0x0004
06	Byte count	1 Byte	2 x N*
07~	Output channel value	N* x 2 Byte	Refer the table as follow

N*= Output channel numbers

Response

00	Address	1 Byte	1-247
01	Function code	1 Byte	0x10
02~03	Starting channel	2 Bytes	Same as byte 02 and 03 of the Request
04~05	Output channel numbers	2 Bytes	Same as byte 04 and 05 of the Request

Output type & Data Format Table

Type Code	Output Range	Data Format	Max.	Min.
0x0030	0 to 20mA	Hexadecimal	0x3FFF	0x0000
0x0031	4 to 20 mA	Hexadecimal	0x3FFF	0x0000
0x0032	0 to 10V	Hexadecimal	0x3FFF	0x0000
0x0033	-10V to +10V	Hexadecimal	0x3FFF	0xC000
0x0034	0 to +5V	Hexadecimal	0x2FFF	0x0000
0x0035	-5V to +5V	Hexadecimal	0x2FFF	0xC000

****Channel output value should be in hexadecimal form and should be between range of maximum & minimum value that depend on each type code.**

Slew rate table.

	0x0000	0x0001	0x0002	0x0003	0x0004	0x0005	0x0006	0x0007
V/sec	Immediate	0.0625	0.125	0.25	0.5	1.0	2.0	4.0
mA/sec		0.125	0.25	0.5	1.0	2.0	4.0	8.0

	0x0008	0x0009	0x000A	0x000B	0x000C	0x000D	0x000E	0x000E
V/sec	8.0	16.0	32.0	64.0	128.0	256.0	512.0	1024.0
mA/sec	16.0	32.0	64.0	128.0	256.0	512.0	1024.0	2048.0

06(0x06) Write the Module address/baudrate

Request

00	Address	1 Byte	1-247
01	Function code	1 Byte	0x06
02~03	Starting channel	2 Bytes	0x01E4 for Address 0x01E5 for Baudrate
04~05	Output channel value	2 Bytes	0x0000~0x00FF for address Baudrate Refer the table as follow

Response

00	Address	1 Byte	1-247
01	Function code	1 Byte	0x06
02	Starting channel	2 Byte	Same as byte 02 and 03 of the Request
03	Output channel value	2 Byte	Same as byte 04 and 05 of the Request

Baudrate Setting

	Baud Rate
0x0003	1200 BPS
0x0004	2400 BPS
0x0005	4800 BPS
0x0006	9600 BPS
0x0007	19200 BPS
0x0008	38400 BPS
0x0009	57600 BPS
0x000A	115200 BPS

01(0x01) Read WDT timeout status

Request

00	Address	1 Byte	1-247
01	Function code	1 Byte	0x01
02~03	Starting channel	2 Bytes	0x010D
04~05	Read WDT timeout status	2 Bytes	0x0001

Response

00	Address	1 Byte	1-247
01	Function code	1 Byte	0x01
02	Byte count	1 Byte	1
03	Read WDT timeout status	1 Byte	0x00 The WDT timeout status is clear 0x01 The WDT timeout status is enable

Error Response

00	Address	1 Byte	1-247
01	Function code	1 Byte	0x81
02	Exception code	1 Byte	Refer to the Modbus standard for more details.

03(0x03) Read WDT timeout Value

Request

00	Address	1 Byte	1-247
01	Function code	1 Byte	0x03
02~03	Starting channel	2 Bytes	0x01E8
04~05	Read WDT timeout value	2 Bytes	0x0001

Response

00	Address	1 Byte	1-247
01	Function code	1 Byte	0x03
02	Byte count	1 Byte	2
03~	Read WDT timeout value	1 Byte	0x0000~0x00FF WDT timeout value, 0~255, in 0.1 second

Error Response

00	Address	1 Byte	1-247
01	Function code	1 Byte	0x83
02	Exception code	1 Byte	Refer to the Modbus standard for more details.

03(0x03) Send Host OK

Request

00	Address	1 Byte	1-247
01	Function code	1 Byte	0x03
02~03	Starting channel	2 Bytes	0x3038
04~05	Send Host OK	2 Bytes	0x0000

No Response

04(0x04) Send Host OK

Request

00	Address	1 Byte	1-247
01	Function code	1 Byte	0x04
02~03	Starting channel	2 Bytes	0x3038
04~05	Send Host OK	2 Bytes	0x0000

No Response

05(0x05) Set WDT timeout /Clear WDT timeout status

Request

00	Address	1 Byte	1-247
01	Function code	1 Byte	0x05
02~03	WDT timeout	2 Bytes	0x0104 Set WDT timeout enable/disable 0x010D Clear WDT timeout status
04~05	WDT timeout	2 Bytes	0xFF00 for WDT timeout enable 0x0000 for WDT timeout disable 0xFF00 for Clear WDT timeout status

Response

00	Address	1 Byte	1-247
01	Function code	1 Byte	0x05
02~03	WDT timeout	2 Bytes	The value is the same as byte 02 and 03 of the Request
04~05	WDT timeout	2 Bytes	The value is the same as byte 04 and 05 of the Request

Error Response

00	Address	1 Byte	1-247
01	Function code	1 Byte	0x85
02	Exception code	1 Byte	Refer to the Modbus standard for more details.

06(0x06) Set WDT timeout Value

Request

00	Address	1 Byte	1-247
01	Function code	1 Byte	0x06
02~03	Starting channel	2 Bytes	0x01E8
04~05	WDT timeout value	2 Bytes	0x0000~0x00FF WDT timeout value, 0~255, in 0.1 second

Response

00	Address	1 Byte	1-247
01	Function code	1 Byte	0x06
02~03	WDT timeout value	2 Bytes	The value is the same as byte 02 and 03 of the Request
04~05	WDT timeout value	2 Bytes	The value is the same as byte 04 and 05 of the Request

Error Response

00	Address	1 Byte	1-247
01	Function code	1 Byte	0x86
02	Exception code	1 Byte	Refer to the Modbus standard for more details.

Modbus Mapping Table:

ADDR	Item	Attribute
00257	Protocol, ASCII & Modbus select. For function (0x01) : = 1 - Modbus RTU For function (0x05) : 0xFF00 = Modbus RTU 0x0000 = ASCII For function (0x0F) : 1 = Modbus RTU.	R/W
00261	Host watchdog enable/disable For function (0x01) : = 1 - enable For function (0x05) : 0xFF00 = enable For function (0x0F) : 1 = enable.	R/W
00270	Host watchdog timeout status For function (0x01) : = 1 - set For function (0x05) : 0xFF00 = clear For function (0x0F) : 1 = clear	R/W
00273	Read module reset status = 1 - first read after powered on = 0 - not the first read after powered on	R
02241	Enable/Disable DI0 Emergency input flag. For function (0x01) : 1 = enable For function (0x05) : 0xFF00 = enable For function (0x0F) : 1 = enable.	R/W
02242	Enable/Disable DI1 Emergency flag	R/W
02243	Enable/Disable DI2 Emergency flag	R/W
02244	Enable/Disable DI3 Emergency flag	R/W

ADDR	Item	Attribute
10033	Read Emergency DI0 Input channel. 1 = input high level (ON) 0 = input low level (OFF)	R
10034	Read Emergency DI1 Input channel.	R
10035	Read Emergency DI2 Input channel.	R
10036	Read Emergency DI3 Input channel..	R

ADDR	Item	Attribute
40001	Current analog output value of channel 0 Error Response (offset 02): = 0x00 - valid command = 0x02 - invalid start address = 0x03 - invalid data value = 0x04 - host WDT timeout = 0x05 - return if Emergency DI flag is active	R/W
40002	Current analog output value of channel 1	R/W
40003	Current analog output value of channel 2	R/W
40004	Current analog output value of channel 3	R/W
40193	Power on analog output value of channel 0	R/W
40194	Power on analog output value of channel 1	R/W
40195	Power on analog output value of channel 2	R/W
40196	Power on analog output value of channel 3	R/W
43001	Safe value of analog output channel 0	R/W
43002	Safe value of analog output channel 1	R/W
43003	Safe value of analog output channel 2	R/W
43004	Safe value of analog output channel 3	R/W
40257	Type code channel(0)	R/W
40258	Type code channel(1)	R/W
40259	Type code channel(2)	R/W
40260	Type code channel(3)	R/W
40289	slew rate control for channel 0	R/W
40290	slew rate control for channel 1	R/W
40291	slew rate control for channel 2	R/W
40292	slew rate control for channel 3	R/W
40489	Host watchdog timeout value (0~255, in 100ms)	R/W
40492	Host watchdog timeout count, write 0 to clear	R/W
40485	Module address, valid range: 1 ~ 247	R/W
40486	Baudrate setting(CC)	R/W